



# ZT ELITE MODELS ZERO-TURN MOWER OWNER'S, SERVICE & PARTS MANUAL

For additional information, please see us at  
[www.badboymowers.com](http://www.badboymowers.com)

**TSC** **TRACTOR**  
**SUPPLY CO.**  
TractorSupply.com

Bad Boy, Inc.  
102 Industrial Drive  
Batesville, Arkansas 72501

---

# TABLE OF CONTENTS

Basic Information..... Section 1 (page 4)

Bad Boy Safety Guidelines ..... Section 2 (pages 5–8)

Operation ..... Section 3 (pages 9)

Maintenance ..... Section 4 (page 10)

Storage and Transportation ..... Section 5 (page 10)

Troubleshooting and FAQ.....Section 6 (page 11)

Controls ..... Section 7 (page 12)

Moving In-operable Mower ..... Section 8 (page 13)

Instrumentation ..... Section 9 (page 13)

Mower Blade Maintenance .....Section 10 (page 14)

Greasing Bearings.....Section 11 (pages 14)

How to choose the right blade .....Page 15

Mowing Tips .....Page 16

**SERVICE SECTION BEGINS ON PAGE 17**  
**PARTS SECTION BEGINS ON PAGE 25**  
**LIMITED WARRANTY PAGE 42**



## This manual applies to the following equipment:

### Bad Boy ZT Elite Series

ZT 6000 60" Kohler KT-745

## COMMONLY USED ITEMS AND PART NUMBERS

60" ZT Blade	Hi-Lift Fusion 038-6060-00	Gator Blade 038-6003-00	Wave Blade 038-6016-00
ZT Hydro Filters	063-1050-00		
60" ZT Deck Belt	041-1650-00		
ZT Pump Belt	041-6400-00		
Oil Filter	063-5004-00		
Air Filter	063-5002-00 Pre-cleaner 063-5003-00 Element		
Motor Oil	10W-30 Motor Oil – Bad Boy Synthetic Blend Motor Oil Recommended		
Hydro Oil	20W-50 Motor Oil – Bad Boy Hydrostatic Oil Recommended (Approximately 2.5 quarts/transaxle)		

---

## SECTION 1: BASIC INFORMATION

Congratulations on the purchase of your new Bad Boy Mower! The purpose of this manual is to assist operators in maintaining and operating their machine. The information and instructions in this manual can help you attain years of performance from your new Bad Boy. Also, check out our website to learn more about the Bad Boy family.

- 1.1 All Bad Boy engines use 10W-30 engine oil. For maximum protection, Bad Boy synthetic blend engine oil is recommended.
- 1.2 All Bad Boy hydraulic systems use 20W-50 engine oil (Conventional or Synthetic). Bad Boy Hydrostatic oil is recommended.
- 1.3 All Bad Boy Mowers use hi-temp multi-purpose grease. NLGI No. 2 for the grease fittings.
- 1.4 ZT models have 12 psi in both front and rear tires.
- 1.5 Most Briggs, Kohler, Kawasaki, and Vanguard engines hold approximately two (2) quarts of motor oil. Be careful not to over fill engine oil. Refer to the engine's service manual.

### Warranty Registration

The Warranty Registration form must be completed within 30 days to validate your warranty. As the new equipment owner, you are expected to see that the form is completed and forwarded to Bad Boy, Inc., at time of delivery. Warranty is non transferable. **Warranty registration should be completed by the selling dealership using the on-line registration site.**

### Model/Serial Number

Your ZT model serial numbers are found on the SIN plate underneath seat. Also, these numbers can assist you in the ordering of new parts when replacements become necessary.

### Parts/Service

Only Bad Boy replacement parts are to be used on your mower.

Replacement parts are available through your local Bad Boy Mower Dealer. Remember to always provide the following information when ordering parts:

1. Correct part number
2. Correct serial number

All warranty repair and service must be handled through your authorized Bad Boy Mowers dealer.

To locate the nearest dealer, go to our website and click on Locate a Dealer.

## EVAPORATIVE EMISSION CONTROL WARRANTY STATEMENT

### ***Federal Evaporative Emission Control Warranty: Your Warranty Rights and Obligations***

The Environmental Protection Agency (EPA), and Bad Boy Inc. are pleased to explain the evaporative emission control system's warranty on your 2015 equipment. New equipment that uses spark ignition engines for off-road use must meet stringent anti-smog standards. The evaporative emission control system on your equipment is designed, built, and equipped so it conforms at the time of sale to the ultimate purchaser with the requirements of 40 CFR 1060. The evaporative emission control system is free from defects in materials and workmanship that may keep it from meeting said requirements. Bad Boy Inc. must warrant the evaporative emission control system on your equipment for two years provided there has been no abuse, neglect or improper maintenance. If an evaporative emission control system component does fail in a manner that would cause the equipment to no longer meet the requirements of 40 CFR 1060 within the first two years Bad Boy Inc. will replace the defective component. Your evaporative emission control system may include parts such as fuel tanks, fuel lines, carbon canisters, fuel caps, valves, vapor hoses, clamps, or connectors.



---

## SECTION 2: MOWER SAFETY GUIDELINES

Never allow untrained people to operate this machine. It is the owner's responsibility to get training and see to it that anyone who has permission to use your machine receives the proper training. Do not mow around people. The factory discharge chute is designed to deflect debris downward, but it could be possible for debris to be thrown in a way that can cause damage to people or property. Seek additional training when possible to learn more about safety techniques and practices. **This cutting machine is capable of amputating hands and feet and throwing objects. Failure to observe the following safety instructions could result in serious injury or death.**

### GENERAL OPERATION

- 2.1 Read, understand, and follow all instructions on the machine and in the manual before starting.
- 2.2 Do not put hands or feet near rotating parts or under the machine. Keep clear of the discharge opening at all times.
- 2.3 Always remain seated while operating the machine. If the machine is equipped with Roll Over Protection (ROPs), always buckle your seat belt.
- 2.4 Only allow responsible adults who are familiar with the instructions to operate this machine.
- 2.5 Clear the area of objects such as rocks, wire, toys, etc., which could be thrown by the blades.
- 2.6 Always maintain a safe distance from people and pets just prior to, and during, operation. Stop the machine if anyone enters the area.
- 2.7 Never carry passengers.
- 2.8 Do not mow in reverse unless absolutely necessary. Always look down and behind before and while backing.
- 2.9 Never direct discharged material toward anyone. Avoid discharging material against a wall or obstruction as material may ricochet back toward the operator. Stop the blades when crossing gravel surfaces.
- 2.10 Never operate the machine without the discharge chute, grass catcher, or other safety devices correctly in place and functioning properly.
- 2.11 Slow down before turning.
- 2.12 Always disengage blades, place steering controls in neutral, engage parking brake, and remove ignition key when leaving operators seat. Never leave a running machine unattended.
- 2.13 Disengage blades when not mowing. Shut off engine and wait for all parts to come to a complete stop before cleaning the machine, inspecting the machine for damage, removing the grass catcher, or unclogging the discharge guard.
- 2.14 Always operate machine in daylight or with adequate working lights.
- 2.15 Do not operate the machine while under the influence of alcohol or drugs.
- 2.16 Watch for traffic when operating near or crossing roadways.
- 2.17 Always wear eye protection when operating or servicing the machine.
- 2.18 Always wear ear protection, such as earplugs, while mowing.
- 2.19 Use extra care when loading or unloading the machine into a trailer or truck.
- 2.20 Be alert of surroundings. Watch for rocks, stumps, mounds, depressions, and low hanging limbs or objects that could be potentially hazardous while mowing.
- 2.21 Data indicates that operators 60 years of age and above are involved in a large percentage of riding mower related injuries. These operators should periodically evaluate their ability to operate the riding mower safely enough to protect themselves and others from serious injury.

---

## SLOPE OPERATION

Slopes are a major factor related to loss of control and tip over accidents, which can result in severe injury or death. Operation on all slopes requires extra caution. If you cannot back up the slope, or you feel uneasy on it, do not mow it.

- 2.22 Mow up and down slopes, not across.
- 2.23 Watch for holes, ruts, bumps, rocks, or other hidden objects that tall grass can obscure. Uneven terrain could overturn the machine.
- 2.24 Choose a low ground speed when operating the machine on a slope.
- 2.25 Do not mow on wet grass, the tires may lose traction.
- 2.26 Do not attempt to coast down a slope in the neutral position.
- 2.27 Avoid starting, stopping, or turning on a slope. If the tires lose traction, disengage the blades and proceed slowly, straight down the slope.
- 2.28 Keep all movement on slopes slow and gradual. Sudden changes in speed or direction could cause the machine to roll over.
- 2.29 Use extra care while operating machine with grass catchers or other attachments: they can affect the stability of the machine. Do not use on steep slopes.
- 2.30 Do not try to stabilize the machine by putting your foot on the ground.
- 2.31 Do not mow near drop offs, ditches or embankments. The machine could suddenly roll over if a wheel goes over the edge or the edge caves in.
- 2.32 Be aware of what is located at the bottom of slopes. For example: rocks water, cliffs, and roadways.

## CHILDREN

Tragic accidents can occur if the operator is not alert to the presence of children. Children are often attracted to the machine and the mowing activity. NEVER assume that children will remain where you last saw them.

- 2.33 Keep children out of the mowing area and in the watchful care of a responsible adult other than the operator.**
- 2.34 Maintain alertness and turn machine off if a child enters the area.**
- 2.35 Before and while backing, look behind and down for small children.**
- 2.36 Never carry children, even with the blades shut off. They may fall off and be seriously injured or interfere with safe machine operation. Children who have been given rides in the past may suddenly appear in the mowing area for another ride and be run over or backed over by the machine.**
- 2.37 Never allow children to operate the machine.**
- 2.38 Never leave key in the ignition, especially around children.**
- 2.39 Use extreme care when approaching blind corners, shrubs, trees, or other objects that may block your view of a child.**

## TOWING

- 2.40 Tow only with a machine that has a hitch specifically designed for towing. Do not attach towed equipment except at the hitch point.
- 2.41 Follow the manufacturer's recommendation for weight limits for towed equipment and towing on slopes.
- 2.42 Never allow children or others in or on towed equipment.
- 2.43 On slopes, the weight of the towed equipment may cause loss of traction and loss of control.
- 2.44 Travel slowly and allow extra distance to stop.



---

## SERVICE:

### SAFE HANDLING OF GASOLINE

To avoid personal injury or property damage, use extreme care in handling gasoline. Gasoline is extremely flammable and the vapors are explosive.

- 2.45 Extinguish all cigarettes, cigars, pipes, and all other sources of ignition.
- 2.46 Use only an approved gasoline container.
- 2.47 Never remove gas cap or add fuel with the engine running.
- 2.48 Allow engine to cool before refueling.
- 2.49 Never fuel the machine indoors.
- 2.50 Do not store machine near open flame or source of ignition, such as a water heater or furnace.
- 2.51 Remove gas powered equipment from the truck or trailer and refuel it on the ground. If this is not possible, then refuel such equipment with a portable container, rather than from a gasoline dispenser nozzle.
- 2.52 Never fill gasoline containers inside a vehicle or on a truck or trailer bed with a plastic liner. Always place containers on the ground away from your vehicle before filling.
- 2.53 Keep the nozzle in contact with the rim of the fuel tank or container opening at all times until the fueling is complete. Do not use a nozzle lock-open device.
- 2.54 If fuel is spilled on clothing, change clothing immediately.
- 2.55 Never overfill fuel tank. Replace gas cap and tighten securely. **Tank is full when level reaches bottom of fill tube.**

### GENERAL SERVICE

- 2.56 Never operate machine in a closed area where dangerous carbon monoxide fumes can collect.
- 2.57 Keep all nuts and bolts tight to be sure the equipment is in safe working condition. Never operate a poorly maintained machine.
- 2.58 Do not touch hot areas of the machine.
- 2.59 Never interfere with the intended function of a safety device or reduce the protection provided by a safety device. Check their proper operation regularly.
- 2.60 Keep the entire machine free of grass, leaves, or other debris build up. Clean up oil or fuel spillage and remove any fuel soaked debris. Failure to do so can affect the safety and functionality of the machine, as well as increase the danger of a fire due to contact with the hot surfaces of the machine.
- 2.61 Allow machine to cool before storing.
- 2.62 If you strike something with the mower, turn the mower and blades off, engage the parking brake, and inspect the machine for damage. Repair, if necessary, before resuming.
- 2.63 Never make any adjustments or repairs with the engine running.
- 2.64 Check grass catcher components and the discharge guard frequently and replace with manufacturer's recommended parts, when necessary.
- 2.65 Mower blades are sharp. Wrap the blade or wear gloves before servicing them.
- 2.66 Check parking brake operation frequently. Adjust and service as required.
- 2.67 Maintain or replace safety and instruction labels, as necessary.
- 2.68 Do not attempt to mount a tire without the proper equipment and experience to perform the job.

- 
- 2.69 Always maintain the correct tire pressure. Do not inflate the tires above the recommended pressure. Never weld or heat a wheel and tire assembly. The heat can cause an increase in air pressure resulting in a tire explosion. Welding can structurally weaken or deform the wheel.
  - 2.70 Park machine on level ground. Never allow untrained personnel to service machine. Understand service procedure before doing work.

## SAFETY INTERLOCK SYSTEM

Your Bad Boy mower is equipped with a safety interlock system. This system is designed to prevent serious injury or death to the operator and other people or property damage. The system consists of an operator presence switch in the seat, the parking brake, drive lever neutral position, the mower blade engagement switch, and the ignition switch.

These interlocks are vitally important and must be tested frequently. Following are instructions to test these very important safety precautions. **Note: the operator must be seated properly on the machine during these tests and the engine should have been previously allowed to warm to operating temperature.**

- 2.71 With the parking brake engaged, bring lever arms to their inward position, then attempt to start the machine (the blade actuator should be in off position); the engine should not start.
- 2.72 On a level surface, disengage the parking brake and place lever arms to their outward position, then attempt to start the machine (the blade actuator should be in off position); the engine should not start.
- 2.73 Engage parking brake and leave lever arms in outward position, put blade actuator in the on position, then attempt to start the machine; the engine should not start.
- 2.74 Next, start the engine as stated in the "Mower Operation Section", disengage parking brake, and Very Slowly begin to rise from the seat; the engine should stop.

If any of these tests fail to produce the results indicated and the problem cannot be identified, contact your Bad Boy Mower dealer or the support contacts in the rear of this manual.

## ROLL OVER PROTECTION STRUCTURES (ROPS)

This machine is not equipped with ROPS from the factory. If ROPS are added as an option, it is vital that the rules below are adhered to. ROPS, when used correctly, dramatically decrease the fatality rate in roll-over instances.

- 2.75 Periodically ensure the bolts that attach the ROPS to the machine are securely fastened.
- 2.76 Always operate the machine with the ROPS secured in the upright position.
- 2.77 If the surrounding environment (e.g. low lying limbs, signage, etc.) makes it impossible to mow with the ROPS upright, lower the ROPS at the hinge point, mow the area, then immediately secure the ROPS upright.
- 2.78 Upright ROPS are taller than then operators head. Be aware of this and your surrounding environment, as referenced above. The mower and operator may clear low lying items, but the ROPS may not.
- 2.79 Always wear the provided seat belt when ROPS are utilized. Failure to use the seat belt severely handicaps the safety benefits of the ROPS.
- 2.80 In the event of a roll-over, replace the ROPS before resuming use of the machine.





---

## SECTION 3: MOWER OPERATION

***Never operate the machine with faulty equipment. Always be alert of sudden changes in landscape, as the mower will react differently on slopes or embankments than it will on flat surfaces. Never operate the mower with the discharge chute open. Do not cross terrain, other than grass, with blades turning. This could cause damage to property or bystanders.***

- 3.1 Place parking brake in up position
- 3.2 Drive arms must be in the “open” position. While sitting on the machine, each arm is positioned away from the operator, to the right and left. Drive arms will lock into place and must be in this position to start machine.
- 3.3 Put PTO switch in the OFF position.
- 3.4 If your machine has been equipped with a ROPS (Roll Over Protection System) then you must fasten seatbelt.
- 3.5 If machine has not been started recently, engage the choke.
- 3.6 Make sure nothing is under or around machine.
- 3.7 Place key in ignition and turn.
- 3.8 Once machine is started, disengage the choke.
- 3.9 Increase RPM by sliding the throttle to fast position, toward the rabbit.
- 3.10 Owners must become familiar with the controls before operating a zero-turn radius vehicle.
- 3.11 Start slowly and build your skill level. Have ample practice before using the machine at full capabilities.
- 3.12 Be comfortable with machine before engaging blades. Know what each component controls before using machine.
- 3.13 Your mower will perform differently on an incline /decline. Be cautious, slow down, and do not make any sudden jerking movements with control arms. The machine could lose traction on a decline or tip backwards on an incline.
- 3.14 Once you become comfortable with your Bad Boy Mower you will notice your overall mowing time will decrease.

***Avoid operating your mower on side hills of over 5 degrees,  
inclines of over 10 degrees,  
and declines of over 15 degrees.***

---

## SECTION 4: MOWER MAINTENANCE

*\*\*Check each and provide maintenance when needed.*

### DAILY

- 4.1 Check Engine Oil
- 4.2 Check Engine Air Filter
- 4.3 Tire Pressure and Wheel Lug Nuts
- 4.4 Inspect Blades

***Within FIRST five hours of usage, change engine oil and filter***

### EVERY 30 HOURS OF USAGE

- 4.5 Grease Machine

### EVERY 50 HOURS OF USAGE

- 4.6 Change Engine Oil and Filters

***Replace filters once a year if under 50 hours***

***Check air and fuel filters more often in dry, dusty conditions***

***Within FIRST 50 hours of usage, change hydraulic oil and filters***

### EVERY 250 HOURS OF USAGE

- 4.7 Change Hydraulic Fluid and Filters
- 4.8 Refer to manufacturer manual for specific information on maintenance schedules.

## SECTION 5: MOWER STORAGE & TRANSPORTATION

- 5.1 Keep machine from collecting debris by storing in a covered area while not in use.
- 5.2 Fuel can harm your machine if left for more than 30 days without changing, especially if the fuel contains ethanol. Never use fuel with more than 10% ethanol by volume. E-15 is not permitted.
- 5.3 Disconnect the negative battery cable when machine will be stored for more than 30 days.
- 5.4 Always secure machine properly when transporting machine.
- 5.5 Do not load machine on trailer with blades engaged.
- 5.6 Do not use ramps to load the machine.
- 5.7 Make sure Parking Brake is in “up” position.
- 5.8 In wet conditions tires may spin while loading / unloading. If necessary, wait for dry conditions before loading / unloading.
- 5.9 Make sure mode of transportation is suitable to bear the weight of mower.
- 5.10 Deck height should be set at maximum before attempting to load.
- 5.11 Secure mower with at least two straps capable of securing weight of mower.



---

## SECTION 6: TROUBLESHOOTING

- 6.1 **Q:** *How do I prevent an uneven cutting pattern and increase the quality of cut?*
- 6.1 **A:** Check tire pressure, check blade sharpness (replace blades or sharpen at least once per year or when needed), make sure blades are tightened properly, check spring and belt tension, check the underside of the deck to ensure the mower deck is free of grass build-up and debris, make sure your machine is at full throttle, and vary your mowing pattern each time you cut your grass.
- 6.2 **Q:** *What should I do if my mower won't start?*
- 6.2 **A:** Check battery charge and connection (grounds), check your fuel (make sure fuel is less than 30 days old and contains no water), make sure your spark plug is in good condition and spark plug wire is attached, and make sure air filter is clean (a dirty filter makes it more difficult for the engine to draw air). Check the integrity of the 25 amp main fuse; also check for any bare wires and/or bad connections.
- 6.3 **Q:** *What should I do if the blades won't engage?*
- 6.3 **A:** Make sure the safety switch is plugged in on the bottom of seat. Check the underside of the PTO engager to ensure the plug is secure at switch. Also check PTO fuse underneath operator console (10amps)
- 6.4 **Q:** *What type of fuel is recommended for my mower?*
- 6.4 **A:** We recommend that you use a name brand fuel to ensure quality. Use fuel with an octane rating near 87. Higher octane fuels offer no benefit. By law, E-15 fuel is not permitted. Usage of E-15 will result in premature engine failure.
- 6.5 **Q:** *Do you offer touch-up paint for your mowers?*
- 6.5 **A:** Touch-up paint is available. Contact your local dealer for more information.
- 6.6 **Q:** *How durable is the electric deck lift?*
- 6.6 **A:** The actuator which controls the deck height is designed for moving loads of up to 1000 pounds and has a static holding capability which exceeds 3,000 pounds. Our 1/4" deck weighs approximately 250 pounds which is only 25% of working capability. If deck lift will not operate, check fuse located underneath operator console (15amp).

---

## SECTION 7: CONTROLS

- 7.1 **Ignition Switch**—Bad Boy mowers have a three position ignition switch: off, run, and start. With key inserted, rotate it clockwise to START position and release key when engine starts, and switch will automatically return to the RUN position.
- 7.2 **Throttle Control**—A cable is connected to the engine throttle for controlling engine speed. Move lever forward to increase engine rpm, move lever backward to decrease engine rpm.
- 7.3 **Choke Control**—(Not pictured, located on left side by hand brake) When the lever is in the down position, the choke is in the off (run) position. When the lever is pulled up, the choke is in the on (start) position. Do not operate the machine in the on (start) position.
- 7.4 **Control Levers**—These levers control the mower's speed, direction, and neutral lock. These levers are used to steer, accelerate, decelerate and change direction. (Drive Arms)
- 7.5 **Blade Engage Switch**—This switch engages the blades. Pull the switch up to engage the blades and push the switch down to disengage the blades.
- 7.6 **Deck Lift Control**—The deck lift switch is used to raise and lower the deck.

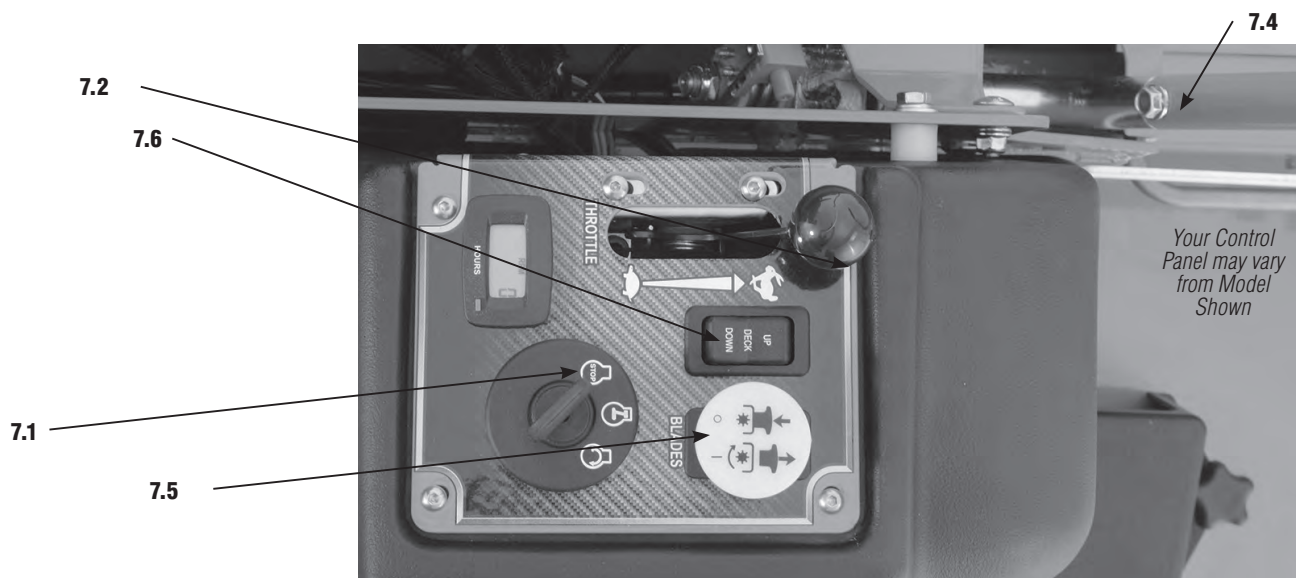



---

## SECTION 8: MOVING INOPERABLE MOWER

- 8.1 Do not tow machine. Use a winch to load on a trailer for transporting.
- 8.2 **ATTENTION:** RETURN BYPASS VALVES TO OPERATING POSITION BEFORE RUNNING MOWER FOLLOWING REPAIRS.
- 8.3 ZT Models are equipped with two neutral engage/disengage arms, located at the rear of the mower protruding from the frame and under the muffler. By pulling the arms out, the mower can be put in a neutral position. Return the arms to the “forward position” for normal operation.
- 8.4 Your Bad Boy Mower Weighs:      **ZT SERIES:**                      **800—850 lbs**  
*\*\*\* Weights fluctuate with the addition of accessories.*
- 8.5 As you can see by the weights of the machines, you shouldn't ever try to push or pull a Bad Boy Mower by hand. This could cause serious bodily injury.
- 8.6 Hopefully, you'll never need to use this section of the manual. However, if you do, use extreme caution when moving machine!

## SECTION 9: INSTRUMENTATION

- 9.1 **Electronic Hour Meter**—Registers Hour increments up to 9,999.9 total hours. This meter records the cumulative time the engine is running.

---

## SECTION 10: MOWER BLADE MAINTENANCE

- 10.1 Check mower blades after each use. This is essential for maintaining well-groomed turf. Keep the blades sharp. If a dull blade is used for cutting, the grass will tear rather than cut. This could damage the grass leaving a brown frayed top on the grass within a few hours. A dull blade will also require more power from the engine.
- 10.2 NEVER attempt to straighten a bent blade by heating. NEVER attempt to weld a cracked blade. The blades can break and cause serious injury or death.
- 10.3 NEVER work with blades while engine is running or deck clutch is engaged.
- 10.4 ALWAYS place deck clutch in DISENGAGE position while performing maintenance.
- 10.5 Use blocks when you MUST work under mower.
- 10.6 ALWAYS wear thick gloves when handling blades.
- 10.7 ALWAYS check for blade damage if mower strikes rock, branch, or other objects that could potentially damage the blade.

***(REMEMBER: NEVER CHECK BLADE WHILE ENGINE IS ON!  
NEVER CHECK BLADES WHILE BLADES ARE ENGAGED!)***

## SECTION 11: GREASING THE BEARINGS

- 11.1 Park the machine on a level surface and disengage the blade control switch.
- 11.2 Move the motion control levers outward to the neutral position, engage parking brake, stop the engine, remove the key, and wait for all moving parts to stop before leaving the operating position.
- 11.3 Grease Type: NLGI grade #2 multi-purpose gun grease. Grease the front caster pivots. 11.4 Clean the grease fittings with a cloth. Scrape any paint off the front of the fitting(s).
- 11.5 Connect a grease gun to each fitting. Pump grease in fittings until grease begins to seep out of the bearings. Wipe up excess grease.
- 11.6 Refer to service manual section for grease fitting locations.



---

## HOW TO CHOOSE THE RIGHT BLADE

Essentially there are only TWO basic styles of mowing blades used or approved for use on our current products:

- 1) The standard style of mowing blade is essentially designed for cutting grass and effectively discharging the clippings out from the deck to fall onto the lawn or to be captured in a grass collection system. Standard blades are also referred to as “2-in-1” (discharging & bagging ) or “high-lift” blades (because they are designed to create a higher-lifting airflow).
- 2) Mulching blades generally have a more curved style surface and frequently include extra cutting surfaces along the blade edges. These blades may also come in a “+” design (which is actually two individual blades arranged in a perpendicular fashion to enhance mulching). The “+” blades are usually found on older style mowers; newer ones utilize blades with more advanced mulching technology. Mulching blades may also be referred to as “3-in-1” (mulching, discharging & bagging) or “all-purpose” blades.

Bear in mind that the re-circulating airflow design of 3/1 blades makes them less efficient at discharging grass clippings than a standard 2/1 blade. As with most all-purpose tools, there is some give and take as opposed to using a tool designed for a more specific purpose.

If you're experiencing less-than-desired cutting or discharging performance with a 3/1 blade, you may want to check into using a 2/1 blade. Conversely, if you're using a 2/1 blade and want to mulch clippings, you should see about the availability of mulching blades or a mulching kit.\*

The type of blade installed on a new mower is a decision the retailer makes for each model of mower, based on the expected needs of most customers. If you're unsure of which blade is on a particular model, inspect the blade. Blades have part numbers stamped into them. Then compare these part numbers with the unit's Operator's Manual or Parts List.

It is true there are many other styles of blades available. But since we don't manufacture or recommend using these other aftermarket styles, we will leave them out of this discussion. Should you want more information on special application or aftermarket blades, you should contact the companies that make these products. NOTE: Customers using non-OEM blades do so at their own risk. The use of unapproved (non-OEM) blades may void any or all of the mower and engine factory warranties.

\* **MULCHING KITS** – These generally consist of mulching blades and a mulching plug (which closes off the discharge opening to keep the clippings contained under the deck for re-cutting) plus any necessary hardware for installation. Please check with your parts distributor regarding the contents of a particular mulching kit.



---

## MOWING TIPS:

- Mow header strips at the ends of the lawn and around flower beds first. Make them wide enough that you can turn the mower around in the already mown section. Then mow back and forth between these header strips overlapping each lap by about 1/8 the width of the mower's deck.
- Don't cut your grass too short, particular for cool season grasses. Higher heights usually provide for a deeper root system, looks better, and is less likely to have weeds invading, particularly crabgrass.
- Don't remove any more than one third of the grass leaf at any one cutting. If circumstances arise that a lawn gets too tall and you just have to lop off a bunch to get caught up, bite the bullet and break it down into several mowings to get caught up with 3 or so days between cuttings.
- **NEVER SCALP YOUR LAWN.** Scalping severely damages the root system to such a degree that it may die.
- Avoid mowing when the grass is wet or when it's dark
- Avoid throwing grass clippings into the street and driveway where they can be washed into the sewer system. After mowing, clean up driveway and walkways.
- When mowing remove only a third with each cutting (except for the first mowing of the season when it's ok to remove more). You can safely leave clippings that will quickly decompose and add nutrients back into the soil. Contrary to popular opinion, grass clippings do not add to thatch buildup. Grass blades are made up of about 75% water.
- Mow your lawn in a different direction with each mowing, especially with lawns of shorter grass types. Altering the direction ensures a more even cut since grass blades will grow more erect and less likely to develop into a set pattern.
- Keep your mower's blade sharp, which means having it sharpened several times during the mowing season. Keep several blades around so you'll always have a sharp one on hand. Sharp blades cut the grass cleanly and help mulch clippings into small pieces which break down quickly.
- Don't forget to change your mower's oil at least once during the mowing season. For brand new mowers, change the oil after about 5 hours of operation during the initial break-in period.
- At the end of the mowing season use a fuel stabilizer in the remaining gasoline
- In the spring, don't use that old gas unless you properly used a fuel stabilizer, it can cause a number of problems. Better to use fresh gasoline to begin the new mowing season.
- **Leaf blade A** demonstrates what a leaf blade should look like after mowing with a sharp blade.
- **Leaf blade B** demonstrates a leaf blade that was injured by a dull mower blade.
- **Leaf blade C** was cut by the mower but indicates that the mower blade is not sharp enough. The shredded white tissue protruding from the leaf blades C and D is the vascular tissue of the plant.
- **Leaf blade D** has been mown for quite some time with a dull mower blade.

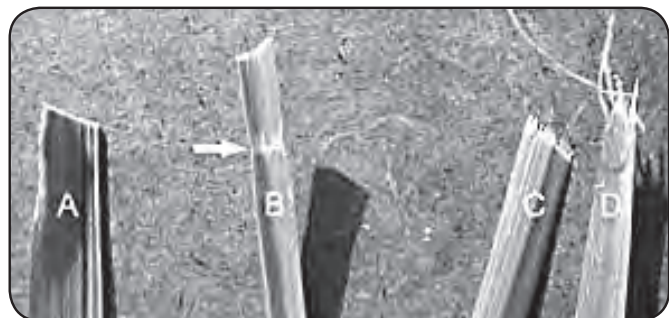

## *To bag or mulch?*

Grass clippings do not contribute to thatch buildup or increase the chances of disease. If you mow your lawn at the right height, without removing any more than 1/3 of it's total height, clippings will quickly breakdown without a trace. These clippings contribute additional nitrogen and other nutrients to the soil and supply it with additional organic materials. Clippings from a 1000 sq. ft. lawn can add as much as 1 - 2 pounds of nitrogen back into the soil.

If you have a compost pile, then you may want to bag your clippings occasionally to add much needed green-matter to the compost pile. Make sure it is mixed thoroughly with brown matter to avoid a strong ammonia odor. **DO NOT COMPOST CLIPPINGS** after applying any weed control or weed-feed type product. Before adding clippings to the compost pile wait at least 3 mowings after these products have been applied.





# SERVICE SECTION

## SECTION 1: HYDROSTATIC SYSTEM

The hydro overflow tanks on a ZT are located on the sides of the rear cover. Notice the “full cold” line at the bottom of the tank. Use only 20w50 motor oil in this tank. (Bad Boy Hydrostatic oil is recommended)



When servicing a mower with a sealed transaxle unit, start by removing the filter skid plate on the bottom of each unit. The skid is held on by three 10mm bolts. Next, remove the filter. The filter also serves as the oil drain. Each transaxle holds about 2 quarts of hydro oil. Install new filters and replace the skid plates. Use only Hydro-Gear® filters. Use of any other type of filter will result in damage to the hydro system and void the warranty. Transaxle service recommended within the first 50 hours of usage and every 250 hours thereafter.

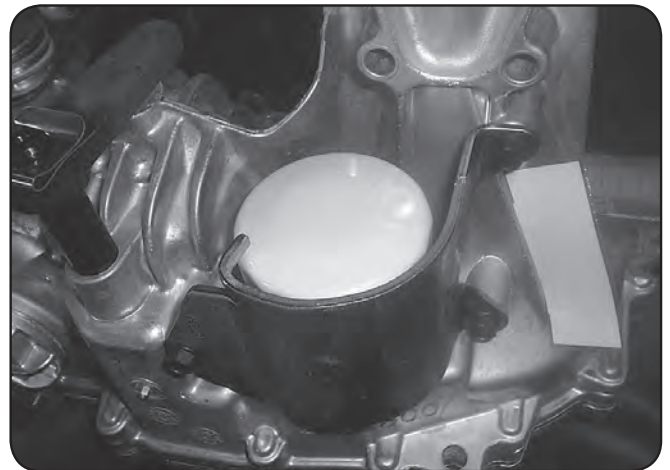

The check plug is located at the top center of the inside case of each transaxle. The transaxle can be filled with oil by removing these check plugs from both transaxles and pouring the oil in the hydro overflow tank, located behind the seat. Oil will begin to run out of the check plug holes when the transaxles are full. Use only 20w50 motor oil in the hydro system.

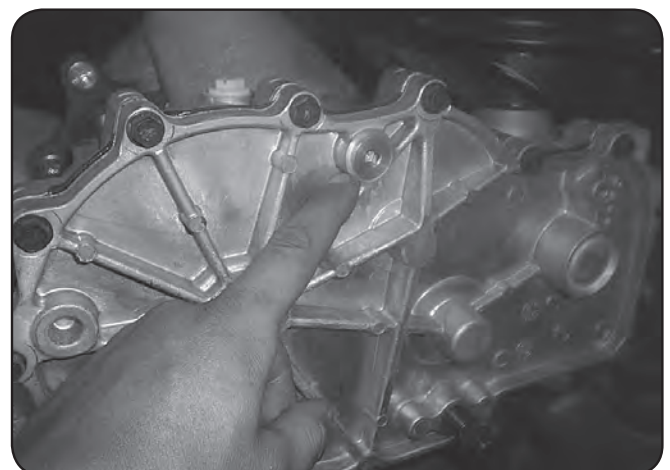

---

Once the system is filled with oil, lift rear of mower until rear tires are off the ground. Start engine, release parking brake, and stay clear of moving rear tires. Next, pull the neutral bypass levers (located at the rear of the frame, on either side of the muffler), then move the drive arms forward and backward 4 to 6 times slowly. This relieves any air that may be trapped in the system. It may be necessary to add more oil to the hydro overflow tank after 10-15 minutes of subsequent usage. These bypass levers also serve as a neutral for moving the mower without the engine running.

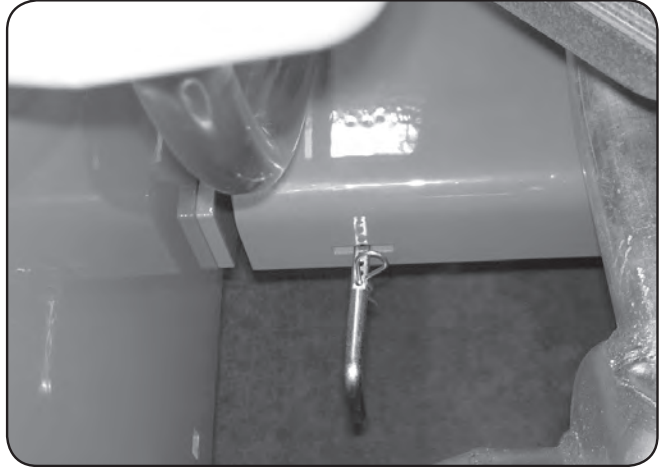

## SECTION 2: DRIVE BELT

Shown on the right is a typical pump belt tensioner for your ZT model mower.

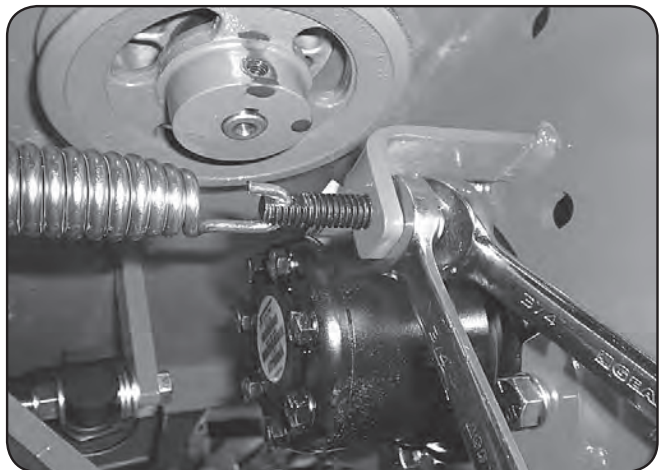

Tightening the two  $\frac{3}{4}$ " jam nuts on the right side will increase the belt tension on all models. Factory setting is about .030" (about the thickness of a credit card) between coils as shown.

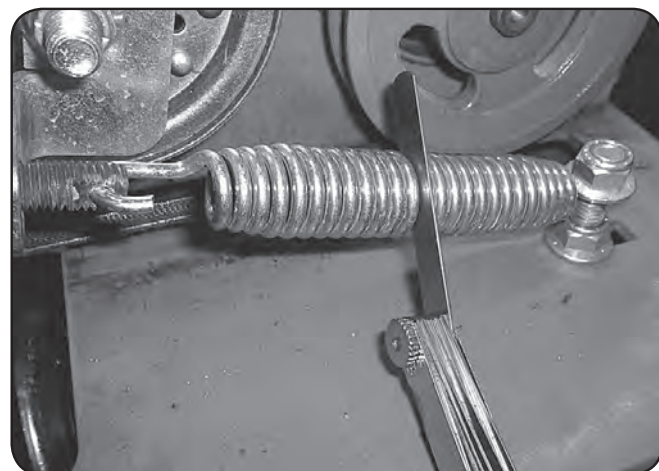



## SECTION 3: ENGINE

Most models have a drain hose installed on the engine for easier oil changes. Bad Boy recommends that the oil and filter be changed at intervals of 50 usage hours or yearly, whichever occurs first. Consult your engine owner's manual for exact oil capacity. Bad Boy 10W-30 synthetic blend engine oil is recommended for maximum protection.



The fuel filter is located in the fuel line about 12" from the carburetor on the side of the engine. Replace the filter yearly. Prior to the removal of the old filter, note the direction of fuel flow as indicated on the filter. Have towels readily available in order to quickly remove any fuel leakage. Always use new hose clamps and ensure the security of the new filter by lightly pulling on each hose. Always perform maintenance outdoors or in a well ventilated area. Do not smoke or allow any open flames in the vicinity of any maintenance activities.

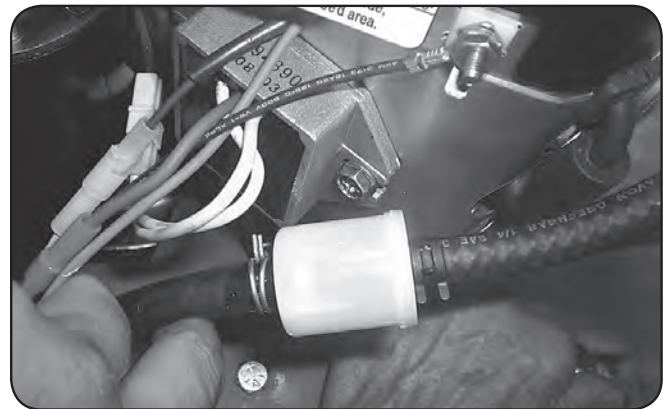

The air cleaner is the engine's only defense against damaging foreign particles. It is very important that the air cleaner element is inspected prior to each use. Remove the element and tap its sides in order to remove debris. Do not blow the filter out using compressed air. Doing so will greatly reduce the air cleaner's effectiveness. Replace yearly; more often in dusty environments. Adhering to these practices will help prevent loss of power and premature engine failure.



Torque the clutch bolt to 50 ft. lbs. on all models.  
Re-torque at every oil change.  
(All Models)

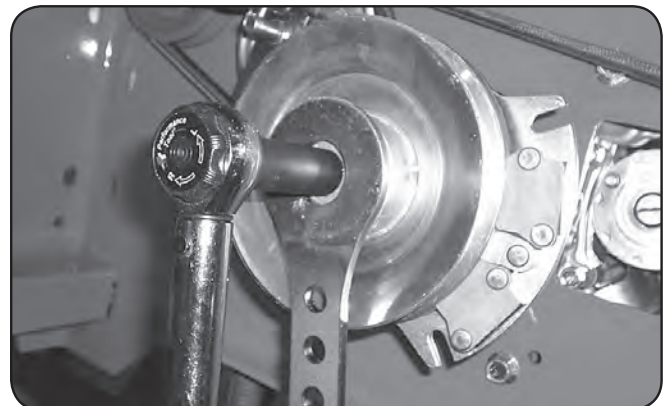



---

## SECTION 4: ELECTRICAL SYSTEM

This mower is equipped with three protective fuses: a 25 amp main fuse (pictured to the right), a 10 amp clutch fuse (blade engagement), and a 15 amp deck lift fuse. The main fuse is located on the left side of the unit; towards the front of the engine. The clutch and deck lift fuses are located just underneath the operator's console. A blown fuse usually indicates a problem within the electrical system or an electrical component. Never replace a fuse with one of a higher amperage rating or 'bypass' a fuse in any way. Doing so creates a significant fire hazard and can cause severe damage to the mower's electrical components. If a fuse is repeatedly blowing, contact your Bad Boy dealer.



Always check the condition of the wiring harness ground cable. The ground is located just inside of the right side fuel tank on most models. Ensure that the ground is connected, clean, and tight.



Check the condition and connection of the relays located under the seat. Ensure that they are clean and connected. Make sure that wire terminal ends have not been pushed out of the relay block.

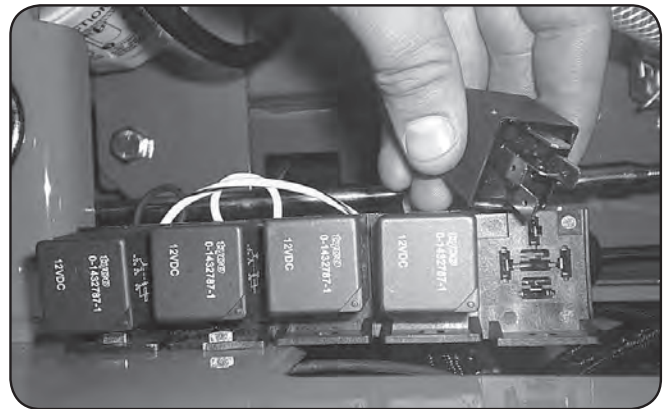

On most models, the red wire coming out of the engine is the charging wire from the alternator. Check for 13.6—14.2 volts DC at this wire with engine at full throttle.



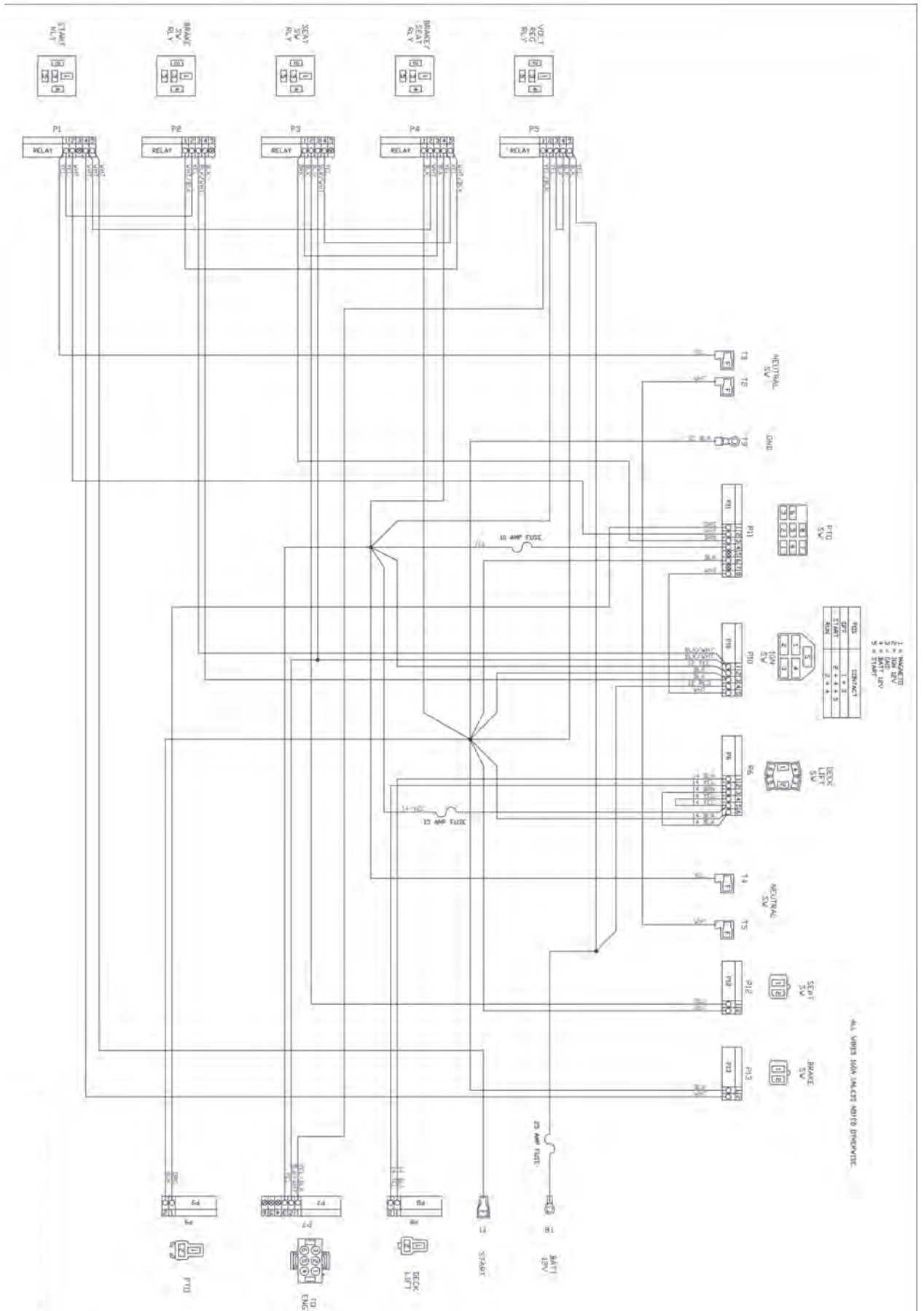

---

## SECTION 5: FRAME

The front fork nuts require a torque of 40ft-lbs. While applying this torque, turn the fork itself to ensure no damage is done to the bearing. This operation is only necessary if a repair requires it.

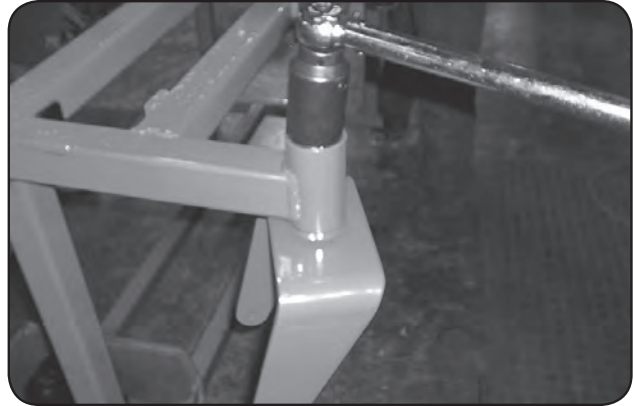

Torque rear wheel lugs to 65-75 ft. lbs. Re-torque at every oil change and check at every mowing.



There is one grease fitting on each of the actuator bar pillow blocks located under the fuel tanks. Grease twice a season.

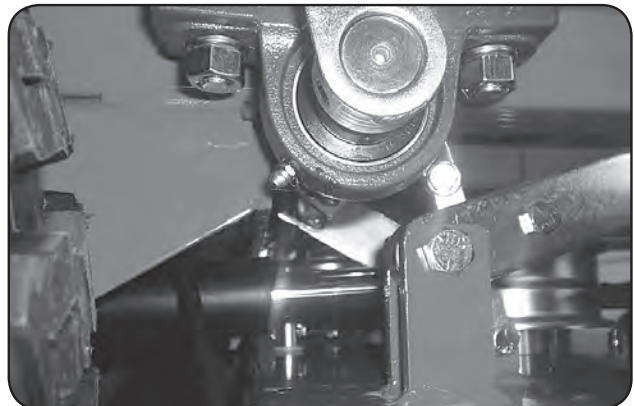



The pump belt tensioner is located under the engine and has a grease fitting at its pivot point. Grease at every engine oil change.



The deck belt tensioner is located at the rear of the deck and has a grease fitting on its pivot point. Grease at every engine oil change.

The control arm blocks have grease fittings located on the top of each block. Grease one time a year.

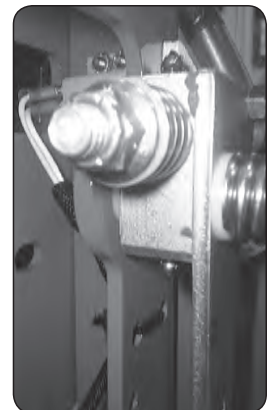

## SECTION 6: CUTTING DECK

Deck belt removal: (1) Remove ignition key. (2) Slide the tension adjustment bolt to its most rearward position in order to provide the lowest belt tension possible. (3) Raise the deck to its highest position. (4) Remove either the right or left blade pulley cover. (5) While lifting up on the belt (as shown in the photograph), rotate the pulley until the belt is free of the pulley. Exercise caution while performing this step as fingers can easily become caught between the belt and pulley.



To check the level of the deck, start on a flat surface and set the air pressure in all four tires. Raise the deck up, and measure all four corners of the deck to see if it is level from left to right and front to back. All decks should be level from left to right and have a 1/8" pitch down in the front.

If deck adjustments are necessary, start with the chain length adjusters. These adjusters affect the overall height of the deck and the level from left to right.

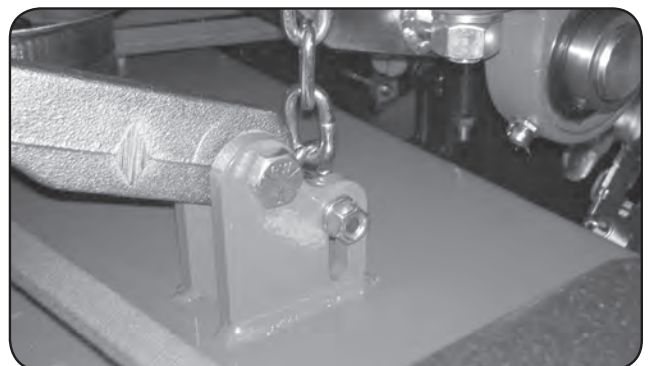



---

The large turn buckles on the front of the deck only affect the pitch of the deck or the level from front to back.



The deck spring tension is critical. If the tension is too high, premature failure of the deck belt and blade spindles can occur. If the tension is too low, the belt can 'jump off' or slip on the pulleys. This results in reduced cut quality and early belt failure. With the deck up, the spring coil gap should be about .025" - .030" (about the thickness of a credit card). Spring tension adjustments can be made by sliding the bolt shown above forward or backward in the slot of the deck. Belt tension should be 50- 55 lbs with the deck at its highest setting.

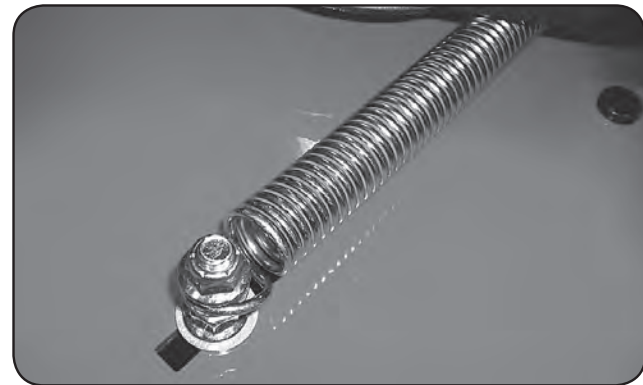

The blade in the foreground (see photo) was utilized long after replacement was required. In addition to a decline in cut quality, failure to replace a worn or damaged blade creates a major safety hazard. Bad Boy recommends that blade sharpening be performed by a professional.



To change blades, it may be easier to use a piece of wood to keep the blade from turning so that the bolt can be loosened. **Bolts used have right-handed threads.** Re-torque the blade bolts to 90-110 lbs. The blade spindles contain a sealed ball bearing inside the top and bottom of the spindle. The bearings are replaceable for a more cost effective repair.

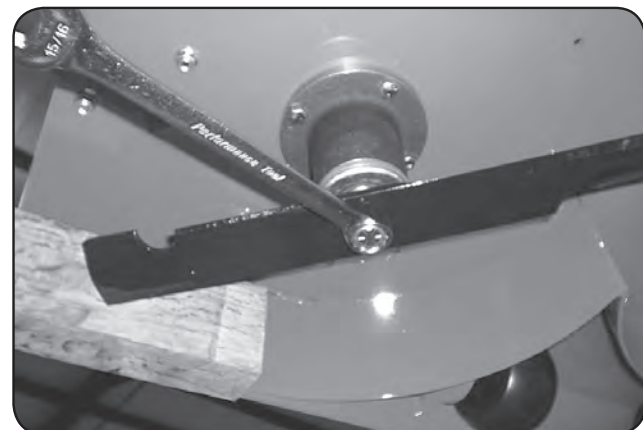



# PARTS SECTION



## ZT ELITE Front Fork Assembly

Parts List			
ITEM	QTY	PART NUMBER	DESCRIPTION
1	1	023-7913-00	Front Fork
2	1	013-8050-00	1/2-13 Nylon Flange Nut-Orange
3	1	018-7010-00	1/2" x 9" Bolt
4	1	022-2006-00	Tire and wheel assembly
5	1	025-5202-00	Front Wheel Spanner
6	2	022-7009-00	Wheel Bearing
7	1	014-2050-00	Rubber Bearing Cap
8	1	013-9004-00	1" Fine Thread 1/2 Nut
9	2	010-2000-00	Caster Bearing -MZ, 2009 & up
10	1	025-0004-00	ZT/CZT Caster Bearing Spacer

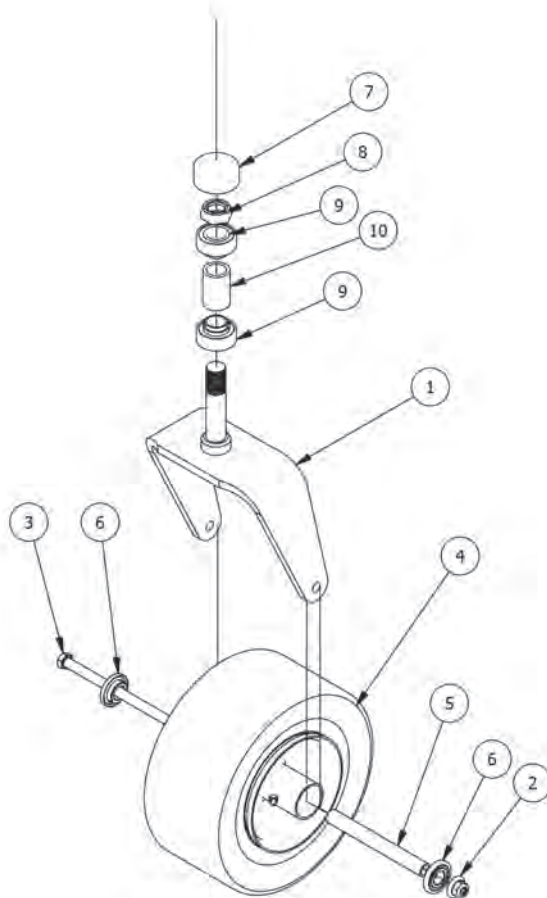

# ZT Drive Arm Assemblies

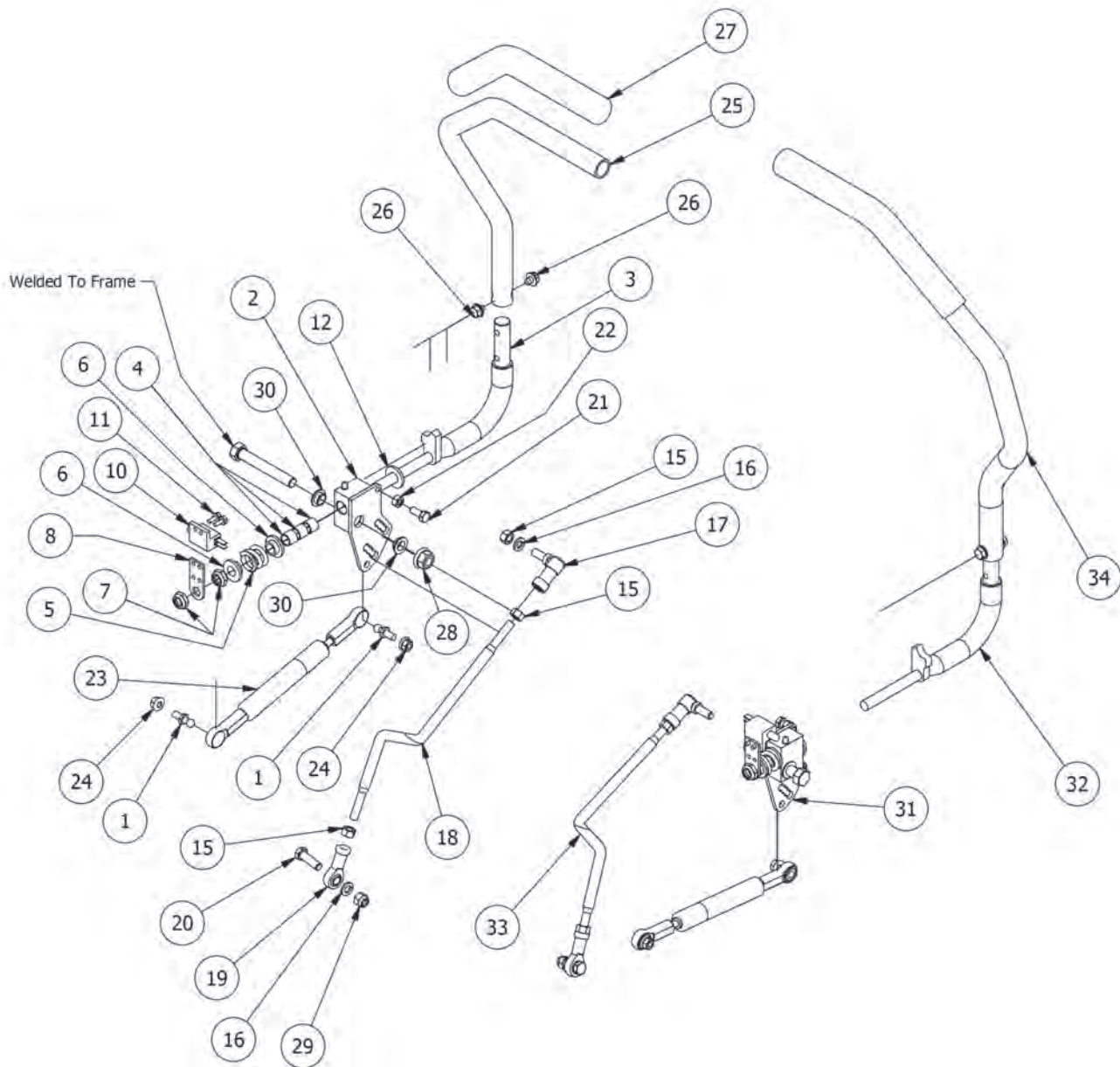



ZT Drive Arm Assemblies			
ITEM	QTY	PART NUMBER	DESCRIPTION
1	2	018-2050-00	10mm Damper Ball Stud-Steering
2	1	027-8900-00	2013 Drive Lever Housing (Left)
3	1	031-9020-70	Steering Arm Elbow - Right
4	6	032-8024-00	.507 ID Nylon Bushing
5	2	034-8025-00	Drive Lever Spring
6	4	019-8027-00	.515 ID Nylon Shoulder Washer
7	4	018-4010-00	1/2" Nylcock Nut (1/2 Jam)
8	2	039-1125-00	MZ Switch Bracket
10	2	077-8073-00	Safety Switch
11	4	018-1080-00	12-24x 1/2 HWH Bolt
12	2	019-8054-00	.505 Nylon Spacer
15	6	013-6051-00	3/8" Fine Threaded Jam Nut
16	4	019-5037-00	3/8" Lock Washer
17	2	099-2009-00	3/8-24 Quick Release Ball Joint
18	1	035-5451-00	Push Rod for ZT/cZT - Left
19	2	048-3000-00	Spherical Rod End - Outlaw
20	2	018-5040-00	3/8" x 1 1/4" Hex Bolt
21	2	018-8063-00	5/16" x 3/4" Hex Bolt
22	2	013-8043-00	5/16" Nut
23	2	087-3000-00	Steering Damper For Outlaw
24	4	013-9002-00	5/16" Flange Nut
25	1	031-8850-00	ZT Direction Steering Arm (Left)
26	4	018-2020-00	5/16-18 1/2 HWH Bolt-Steering
27	2	069-4007-00	Rubber Grip
28	2	013-0085-00	1/2-13 Hex Flange (GR.G) ZC
29	2	013-5041-00	3/8 Nylock Nut
30	4	032-5000-00	1/2" Oil Impregnated Bushing
31	1	027-8901-00	2013 Drive Lever Housing (Right)
32	1	031-9025-70	Steering Arm Elbow - Right
33	1	035-5450-00	Push Rod for ZT/cZT - Right
34	1	031-8851-00	ZT Direction Steering Arm (right)



# ZT Gas Tank Assemblies

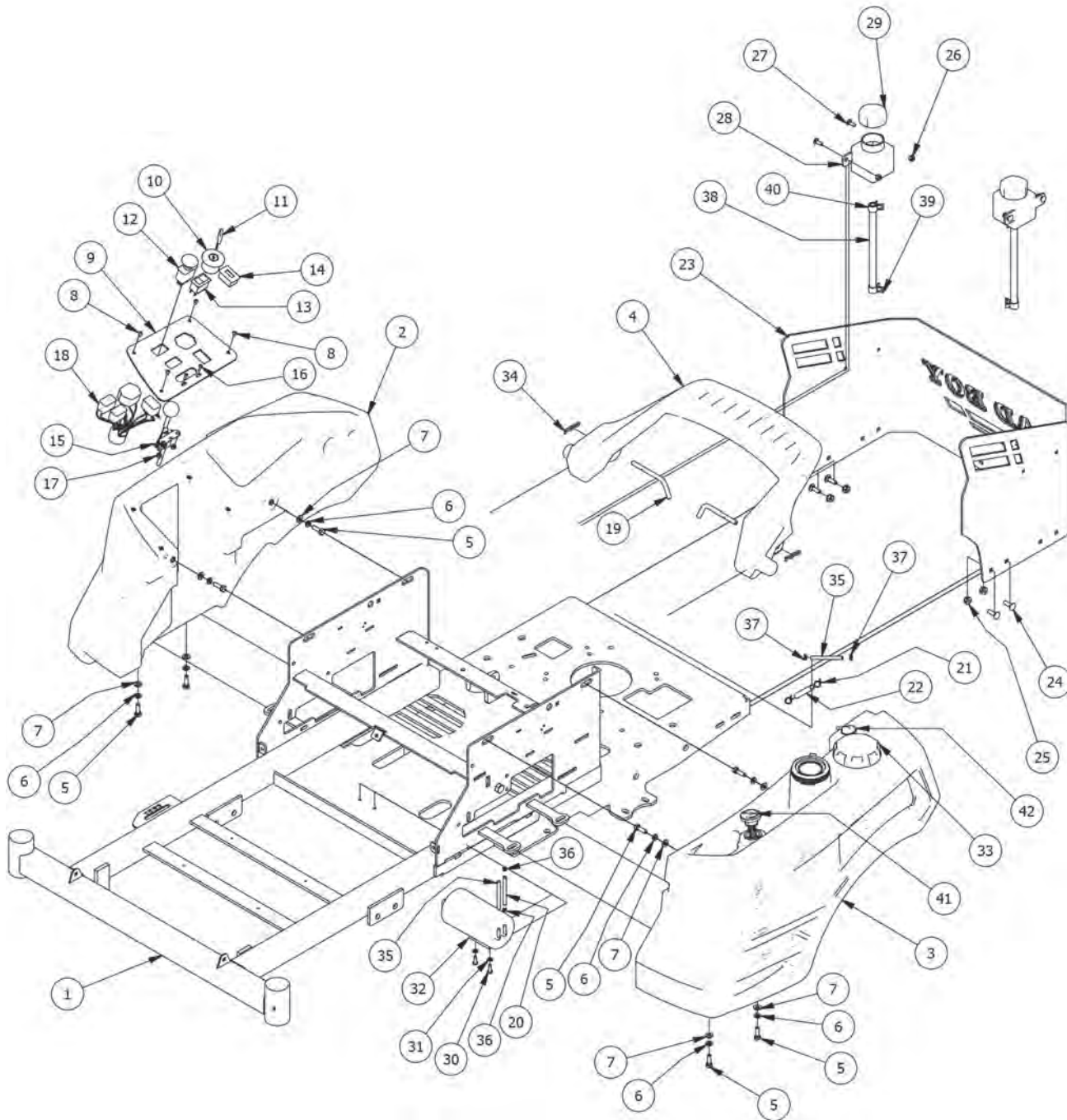



ZT Gas Tank Assemblies			
ITEM	QTY	PART NUMBER	DESCRIPTION
1	1	070-5410-00	ZT/cZT Frame 2013 Models
2	1	067-1000-50	2014 ZT Right Side Console
3	1	067-1001-50	2014 ZT Left Fuel Tank
4	1	067-1050-50	2014 ZT Spoiler
5	8	018-2007-00	5/16" x 1" Bolt
6	8	019-8051-00	5/16" Lock Washer
7	8	019-8044-00	5/16" Flat Washer
8	4	018-2010-00	10-32 x 3/8" Button Socket Head Bolt
9	1	079-3460-00	2014 ZT Control Panel
10	1	077-8076-00	Ignition Switch
11	1	042-9000-00	Ignition Key
12	1	056-8058-00	PTO Engager
13	1	078-3000-00	Rocker Deck Lift Switch - 2011
14	1	083-4013-00	Tachometer
15	1	055-8020-00	Throttle Lever Assembly
16	2	018-5200-00	10-24 X 5/8 BS C/S 18-8 SS
17	2	013-5019-00	10-24 Nylon Insert Locknut
18	1	086-3050-00	Harness-ZT Only-2008 and up
19	2	020-2014-00	Bent Pin-2014 ZT Spoiler
20	1	051-8073-00	3/16 vinyl tubing
21	2	072-8069-00	1/4 fuel clamp
22	1	051-8067-00	1/4" fuel line hose
23	1	026-0080-00	2014 ZT Rear Plate
24	4	018-8065-00	5/16" x 1" Carriage Bolt
25	4	013-8049-00	5/16-18 Nylon Flange Nut
26	4	013-8073-00	1/4" Nylock Nut
27	4	019-8040-00	1/4" x 3/4" Carriage Bolt
28	2	067-8090-00	350ml Expansion Tank-CZT
29	2	066-5050-00	Hydraulic Tank Cap
30	2	018-0024-00	M6-1.0 X 16MM Hex Bolt
31	2	019-4008-00	1/4" Lock Washer
32	1	067-0020-00	Carbon Canister ZT,CZT,Outlaw
33	1	066-8083-00	Fuel Cap
34	2	020-2050-00	Cotter Ping-ZT Spoiler
35	2	051-8072-00	1/4" vinyl tubing
36	2	072-8073-00	3/16" Vinyl Hose Clamp
37	2	072-8070-00	3/16 vinyl clamp
38	2	051-8063-00	3/8 clear hose
39	2	072-8066-00	1/2 Hose Clamp
40	2	072-8065-00	3/8 hose clamp
41	1	067-4050-00	Fuel Gauge Tanks W/downtube
42	1	067-6050-00	Rollover Valve-White



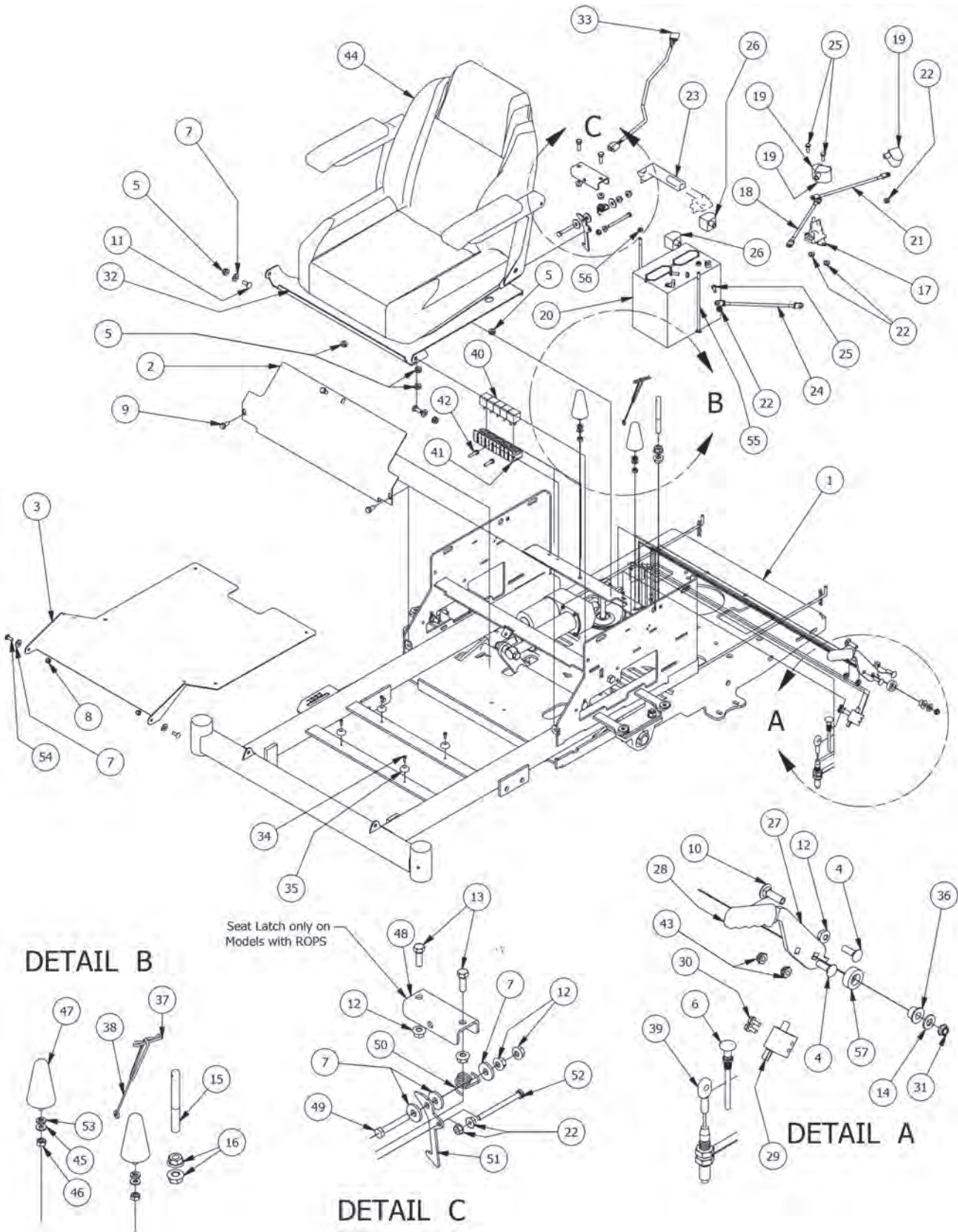



Frame Top Assemblies			
ITEM	QTY	PART NUMBER	DESCRIPTION
1	1	070-5410-00	ZT/cZT Frame 2013 Models
2	1	014-3420-00	2013 ZT/cZT Cooler Cover
3	1	079-3420-00	ZT/CZT FLOOR PANEL
4	6	018-8065-00	5/16" x 1" Carriage Bolt
5	7	013-8049-00	5/16-18 Nylon Flange Nut
6	1	054-8017-00	Choke
7	12	019-6042-00	.360 ID Plastic Washer
8	6	013-8073-00	1/4" Nylock Nut
9	3	030-7042-00	5/16 x 3/4 washer head type F screw
10	3	018-5043-00	3/8" x 1 1/4" Carriage Bolt
11	2	018-8066-00	5/16" x 7/8" Carriage Bolt
12	5	013-9002-00	5/16" Flange Nut
13	3	018-2007-00	5/16" x 1" Bolt
14	3	019-5029-00	3/8" Flat Washer
15	1	044-4000-00	Seat Braket Pin
16	2	013-5300-00	1/2" Flange Nut
17	1	108-5349-00	Solenoid
18	1	064-5300-00	24 in red battery cable
19	3	103-5300-00	Red Boot
20	1	068-8049-00	Battery
21	1	064-5301-00	12 in red battery cable
22	7	013-9001-00	1/4-20 Hex Flange Nuts Zinc w/Serrations
23	1	043-8929-00	Battery Hold Down
24	1	086-0005-00	Starter to chassis cable
25	4	018-8052-00	1/4-20 x 3/4 GR 5 Hex Bolts Zinc
26	2	103-5400-00	Black Boot For ground cable
27	1	069-1000-00	Brake Handle Cam Over
28	1	069-7000-00	Rubber Brake Grip-cZT/ZT 2013
29	1	077-8073-00	Safety Switch
30	2	018-1080-00	12-24x 1/2 HWH Bolt
31	1	013-9003-00	3/8 Nylock Jam Nut 1/2 Nut
32	1	026-1013-00	2013 ZT Seat Plate
33	1	036-5300-00	Seat Switch Adapter
34	4	030-3050-00	#10 x 1/2" Self Taping Screw
35	4	029-4010-00	Button Bumper
36	1	032-5053-00	Bronze Bushing SF-1220-8
37	1	040-6060-00	Seat latch pin
38	1	064-1000-00	seat pin lanyard
39	1	064-3000-00	Brake Cable
40	5	086-1201-00	Relay Terminal
41	1	086-3050-00	Harness-ZT Only 2008 and up
42	2	030-7040-00	1/4 x 1 Hex Head tek screw
43	2	013-9005-00	5/16-18 Nylock Jam Nut 1/2 Nut
44	1	071-2040-00	2013 ZT Seat
45	2	019-7040-00	1/4" Flat Washer
46	2	013-8043-00	5/16" Nut
47	2	034-1444-00	Rubber Cone-1621-153
48	1	039-2020-00	ZT/cZT Seat Latch Bracket
49	1	018-0012-00	5/16-18 X 2 Hex C/S (GR.5) ZC
50	1	034-1075-00	Torsion Spring for Seat latch
51	1	031-0200-00	Seat Latch Lever
52	1	018-2072-00	1/4 x 3 Hex Bolt - Grade 8 - ACS
53	2	019-8051-00	5/16" Lock Washer
54	6	019-8040-00	1/4" x 3/4" Carriage Bolt
55	2	018-8050-00	1/4-20 X 8 Carriage Bolt
56	2	013-8039-00	1/4-20 Hex Nut
57	1	025-0001-00	2015 Brake Lever Spacer

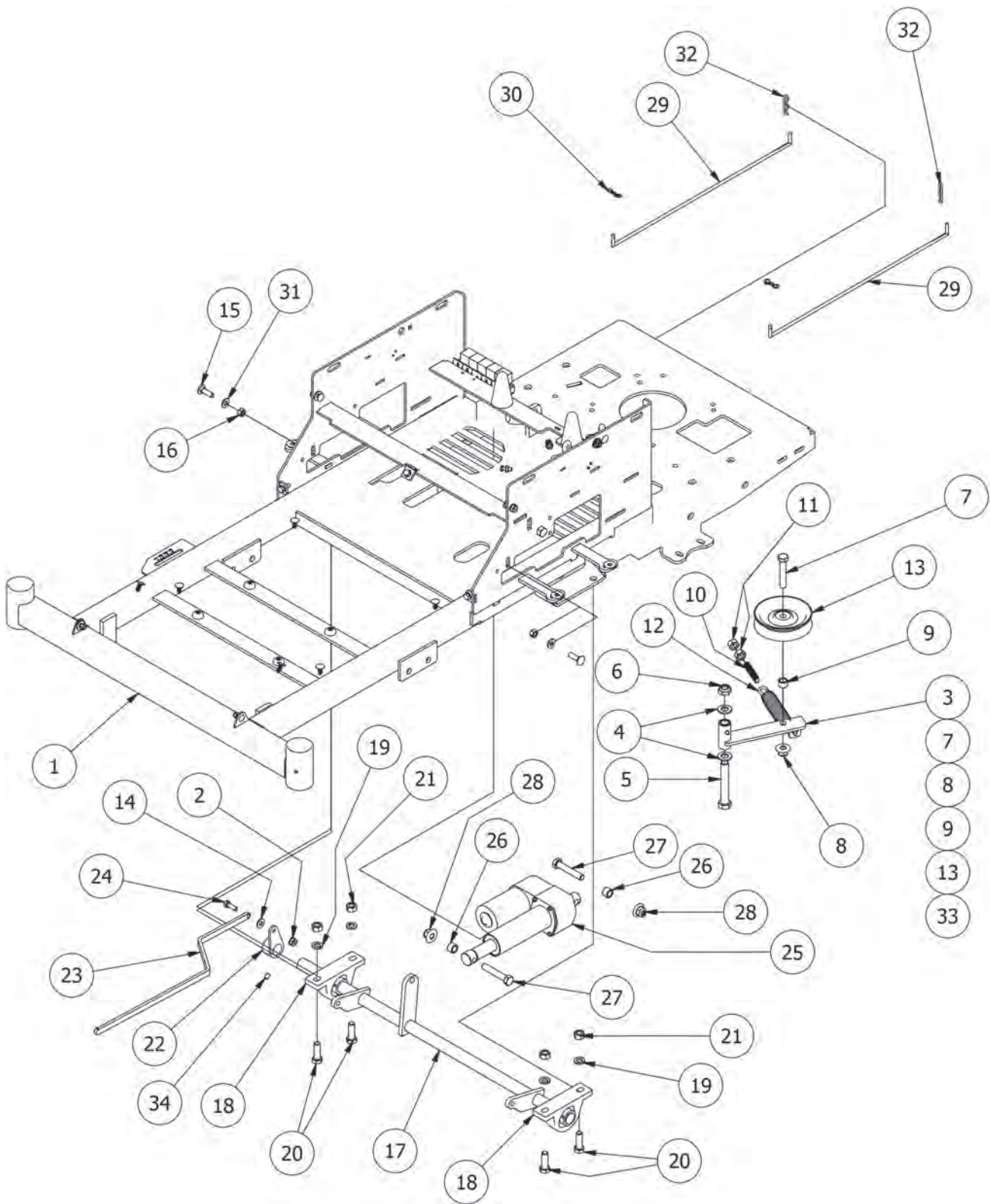





Frame Bottom Assemblies			
ITEM	QTY	PART NUMBER	DESCRIPTION
1	1	070-5410-00	ZT/cZT Frame 2013 Models
2	1	013-8049-00	5/16-18 Nylon Flange Nut
3	1	039-5944-00	Pump Idler Bracket
4	2	019-6017-00	.635 ID Plastic Washer
5	1	018-5311-00	5/8" x 4" Hex Bolt
6	1	013-5301-00	5/8" Nylock (1/2 Jam)
7	1	018-6036-00	1/2" x 2 3/4" Hex Bolt
8	1	013-8050-00	1/2-13 Nylon Flange Nut-Orange
9	1	025-7036-00	1/2 x 1/2 Spacer
10	1	018-2004-00	All Thread-pump Idler Tensioner
11	2	013-7018-00	1/2" Hex Nut
12	1	034-2009-00	2009 Deck/Pump Idler Spring
13	1	033-6001-00	4 3/4" Idler Pulley
14	12	019-6042-00	.360 ID Plastic Washer
15	3	018-5043-00	3/8" x 1 1/4" Carriage Bolt
16	2	013-6014-00	3/8" Hex Nut
17	1	028-4020-00	Actuator Bar-Transaxle
18	2	017-7008-00	pillow block 2bolt sealmaster
19	4	019-5007-00	1/2" Lock Washer
20	4	018-5006-00	1/2" x 1 1/2" Hex Bolt
21	4	013-7018-00	1/2" Hex Nut
22	1	031-7000-00	Height Indicator Lever
23	1	028-2502-00	Height Indicator Bar
24	3	018-2007-00	5/16" x 1" Bolt
25	1	035-7033-00	Actuator
26	2	025-7036-00	1/2 x 1/2 Spacer
27	2	018-6036-00	1/2" x 2 3/4" Hex Bolt
28	2	013-8050-00	1/2-13 Nylon Flange Nut-Orange
29	2	031-0060-00	ZT Neutral level rod 2011
30	2	044-2004-00	Bow Pin
31	3	019-5029-00	3/8" Flat Washer
32	2	044-2008-00	Neutral Rod Clip
33	1	039-5944-98	Pump Idler Assembly (Components 3,7,8,9,13)
34	1	030-0050-00	5/16 Set Screw

# ZT Transaxle Assembly

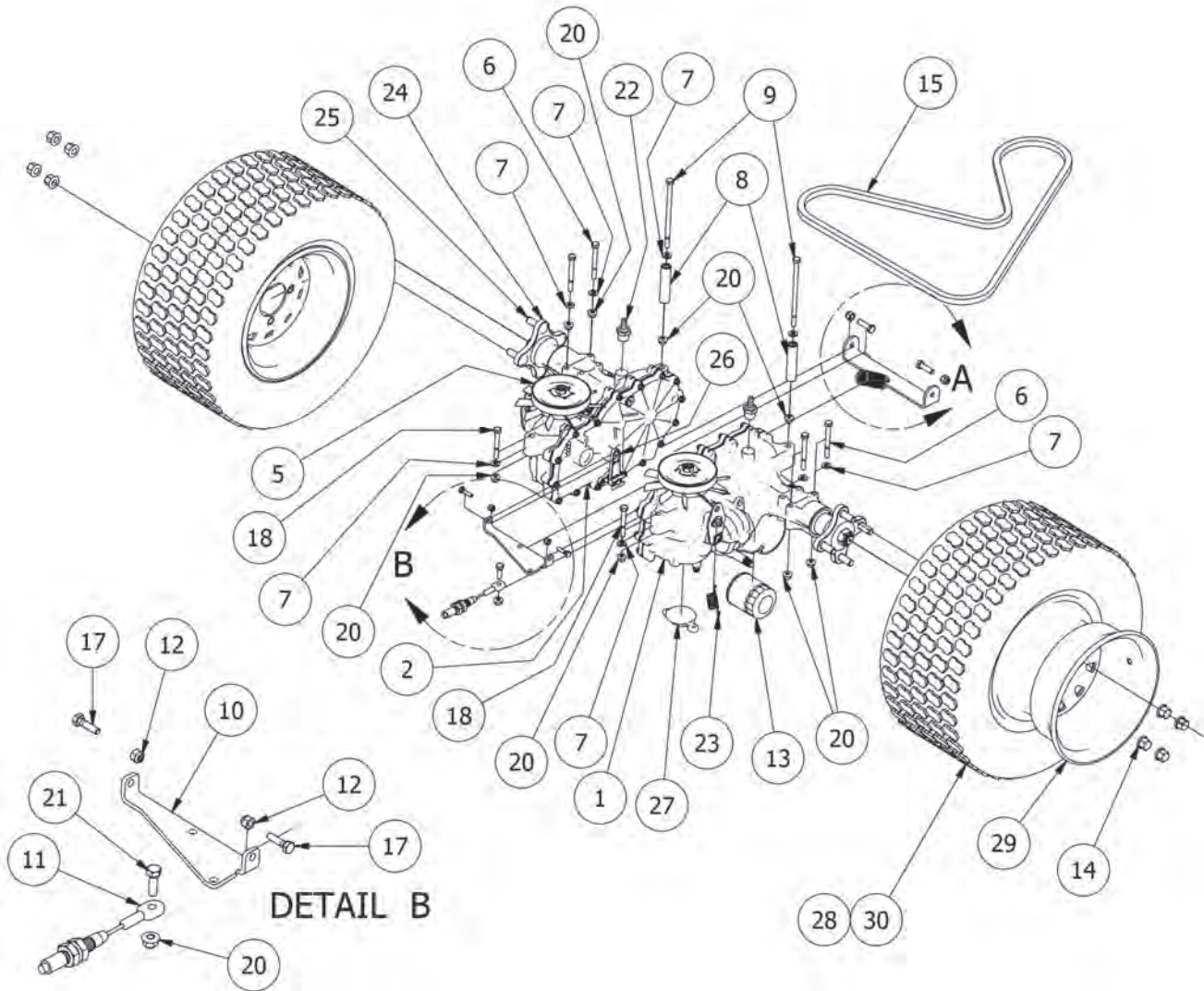
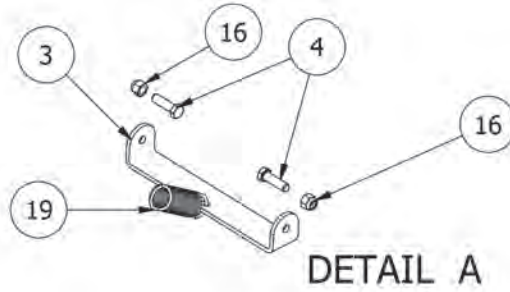





ZT Transaxle Assembly			
ITEM	QTY	PART NUMBER	DESCRIPTION
1	1	050-2081-00	Left ZT Transaxle
2	1	050-2080-00	Right ZT Transaxle
3	1	028-4801-00	Crossover Bar for ZT
4	2	018-3000-00	3/8" x2" Hex Bolt
5	2	050-2075-00	Fan/Pulley Kit
6	4	018-4701-00	5/16" x 3" Hex Bolt
7	8	019-8044-00	5/16" Flat Washer
8	2	025-5340-00	3 1/4" Spacer
9	2	018-5355-00	5/16" x 6" Bolt
10	1	039-0053-00	ZT Crossover Brake Bracket
11	1	064-3000-00	Brake Cable Stand On
12	2	013-8073-00	1/4" Nylock Nut
13	2	063-1050-00	Transaxle Filter
14	8	013-3000-00	Acorn Lug Nut
15	1	041-6400-00	Pump Belt
16	2	013-5041-00	3/8 Nylock Nut
17	2	018-4007-00	1/4-20 x 1 GR 5 hex bolt zinc
18	2	018-5344-00	5/16" x 2 1/2" Bolt
19	1	034-9000-00	ZT spring
20	9	013-8049-00	5/16" Nylon Flange Nut
21	1	018-2007-00	5/16" x 1" Bolt
22	2	024-1200-00	45 degree fitting
23	2	034-9080-00	Transaxle Spring
24	2	050-2076-00	ZT Transaxle Hub
25	8	050-2012-00	Transaxle Wheel Studs
26	1	092-8000-00	Transaxle Brake Lever
27	2	050-2071-00	ZT Transaxle Charge Plate/With O'Ring
28	2	022-2014-00	2014 ZT Assembly 22x11-10(Wheel and Tire)
29	1	022-2021-00	2014 ZT Wheel Only 22x11-10
30	1	022-2020-00	2014 ZT Tire Only 22x11-10

# Kohler 725&747cc Engine Assembly

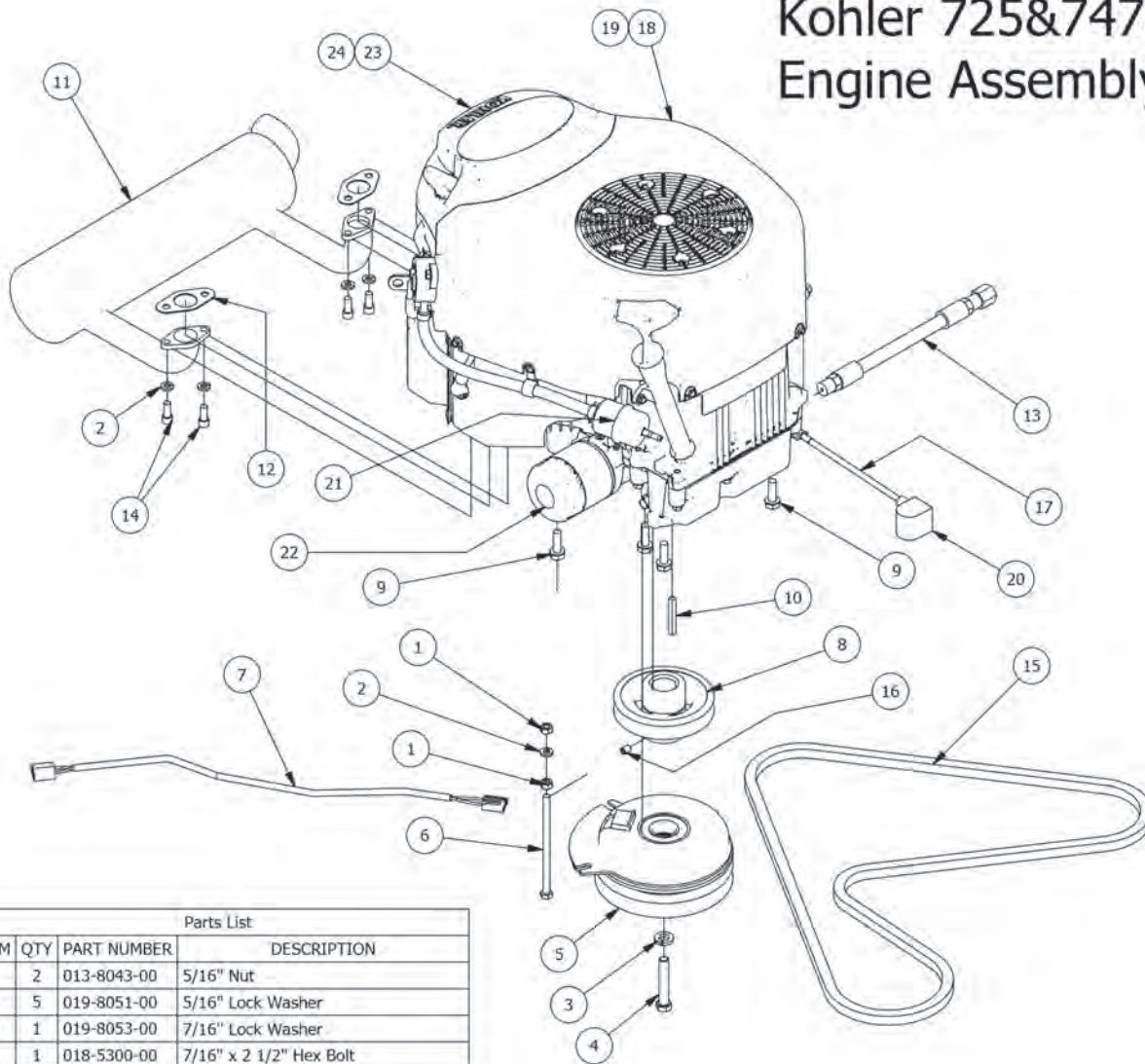

Parts List			
ITEM	QTY	PART NUMBER	DESCRIPTION
1	2	013-8043-00	5/16" Nut
2	5	019-8051-00	5/16" Lock Washer
3	1	019-8053-00	7/16" Lock Washer
4	1	018-5300-00	7/16" x 2 1/2" Hex Bolt
5	1	070-1000-00	Clutch Assembly
6	1	018-5350-00	5/16-18 x 5-1/2 GR 5 Hex Bolt
7	1	070-2000-00	Clutch Pigtail
8	1	033-5035-00	4 3/4 Motor Pulley
9	4	018-1075-00	3/8 x 1 1/8 bolt
10	1	042-5020-00	1/4 x 2 Square key Stock
11	1	015-2750-00	Kohler Exhaust
12	2	015-2751-00	Exhaust Gasket
13	1	051-5401-00	Oil drain Hose
14	4	018-8067-00	5/16-18 x 3/4 Socket C/S
15	1	041-6400-00	Pump Belt
16	1	030-0050-00	5/16 Set Screw
17	1	086-0005-00	Starter to chassis cable
18	1	015-2020-00	Kohler-2014 ZT 725cc
19	1	015-2025-00	Kohler-2014 ZT 747cc
20	1	103-5400-00	Black Boot For ground cable
21	1	063-5001-00	725 & 747 Kohler Fuel Filter
22	1	063-5004-00	725 Kohler Oil Filter ZT/MZ
23	1	063-5002-00	725 & 747 Kohler precleaner ZT/MZ
24	1	063-5003-00	725 & 747 Kohler Air Element ZT/MZ



# ZT 60" Deck Assembly

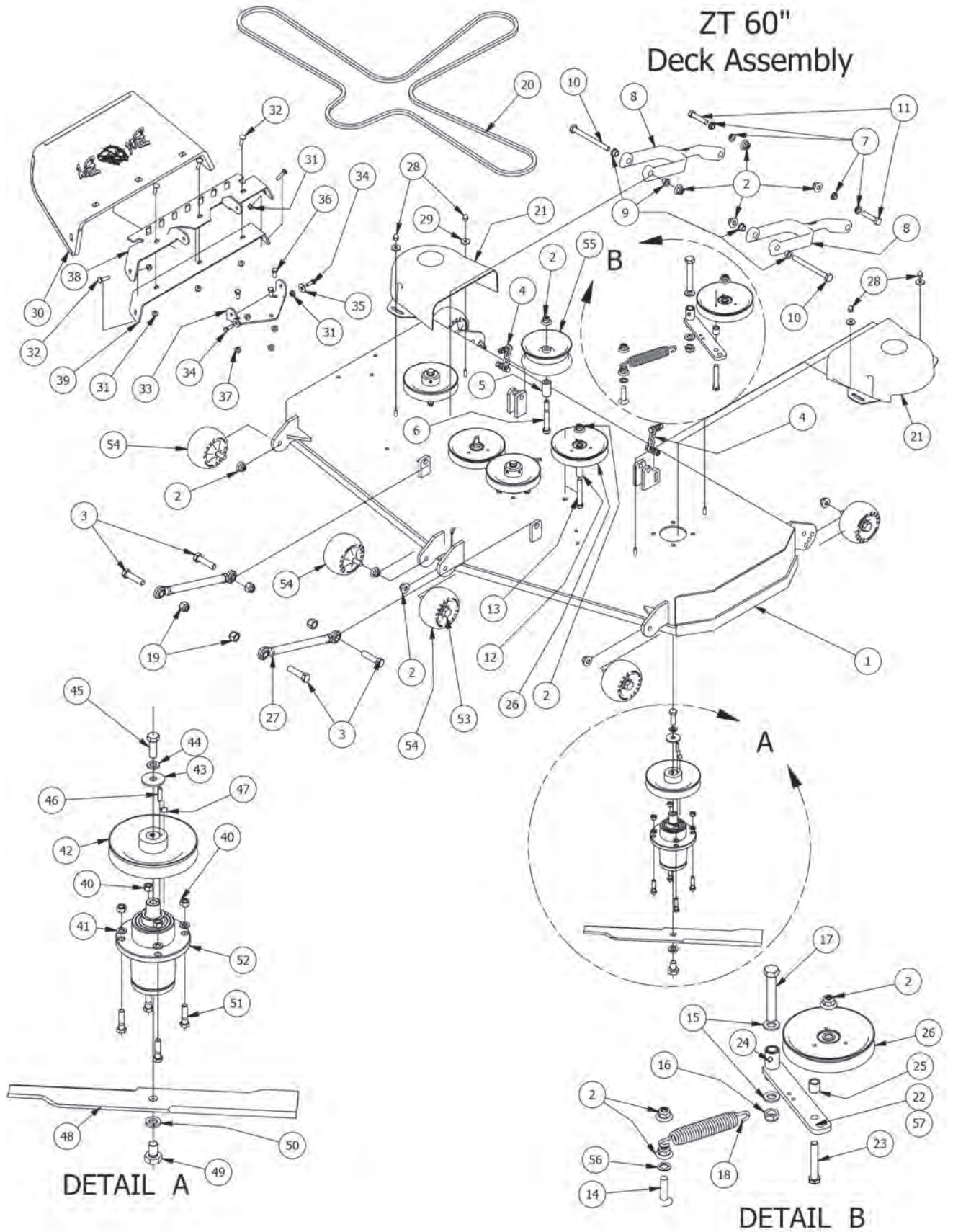

60" ZT Deck Assembly			
ITEM	QTY	PART NUMBER	DESCRIPTION
1	1	060-6060-00	2014 60" ZT/ cZT Deck
2	16	013-8050-00	1/2-13 Nylon Flange Nut-Orange
3	4	018-6059-00	5/8" x 2 1/2" Gr5 Hex Bolt (Coarse)
4	2	047-6050-00	Chain assembly
5	1	025-5339-00	1 3/4" Pulley Spacer
6	1	018-5019-00	1/2" x 4" Bolt (Grade 8)
7	4	032-5057-00	Flange for Lower Deck Arm
8	2	031-6020-00	Deck Arm Assembly
9	4	032-5056-00	Flange Bushing For Deck Arm upper
10	2	018-1090-00	1/2" x 5 1/2" Bolt
11	2	018-6037-00	1/2-13X 2-1/4 GR Hex Bolts
12	2	025-5338-00	.502 ID X .75 OD X 1.500 Leng
13	2	018-2018-00	1/2 x 3 1/2 Flange Bolt Grade 8
14	1	018-1050-00	1/2 x 2" Carriage Bolt
15	2	019-6017-00	.635 ID Plastic Washer
16	1	013-5301-00	5/8-11 Nylon Insert Jam Half Nut
17	1	018-5311-00	5/8" x 4" Hex Bolt
18	1	034-2009-00	2009 Deck/Pump Idler Spring
19	4	013-7021-00	5/8 Std NC Nylock Nut
20	1	041-1650-00	60" ZT Deck Belt
21	2	014-5000-00	2014 ZT Pulley Cover
22	1	039-6945-00	Deck Idler
23	1	018-7016-00	1/2-13 x GR 5 Hex Bolt Zinc
24	1	024-6034-00	1/4" Press in Grease Fitting
25	1	025-5203-00	3/4 OD x 1/2 ID x 3\4 Length
26	3	033-7201-00	5-3/4 Idler Pulley
27	2	048-6060-00	Turnbuckle (Top Link)
28	4	013-0004-00	Acorn nut-pulley Cover
29	4	019-6050-00	.360 ID Plastic Washer-Black
30	1	210-6005-00	Rubber Discharge Chute
31	7	013-8049-00	5/16" Nylon Flange Nut
32	5	018-4703-00	5/16" x 1 1/4" Carriage Bolt
33	1	206-6017-00	Discharge Chute Hanger (deck mounted)
34	2	018-2007-00	5/16" x 1" Bolt
35	2	019-6042-00	.360 ID Plastic Washer
36	3	018-5250-00	3/8" x 3/4" Hex Bolt
37	3	013-5201-00	3/8" Flange Nut
38	1	039-4864-00	60" Discharge Chute Upper Hanger
39	1	039-4863-00	60" Lower Hanger
40	12	013-6014-00	3/8" Hex Nut
41	12	019-5037-00	3/8" Lock Washer
42	3	033-6004-00	6 1/4" Drive Pulley
43	3	019-6020-00	1/2 Belleville Washer
44	3	019-5007-00	1/2" Lock Washer
45	3	018-6019-00	1/2"-20 x 1 1/2 - Grade 5 Fine Thread Bolt
46	3	042-6030-00	1/4" x 1" Key
47	3	030-0050-00	5/16 Set Screw
48	3	038-6060-00	60 Inch Fusion Blade
49	3	018-6020-00	5/8" x 1 1/2" Gr8 Hex Bolt (Fine)
50	3	019-4807-00	5/8" Lock Washer
51	12	018-6012-00	3/8" x 1 1/2" Hex Bolt
52	3	037-6015-50	ZT/CZT SPINDLE ASSEMBLY
53	6	018-0010-00	Deck Wheel Bolt
54	6	022-1000-00	Anti-Scalp Rollers
55	1	033-5000-00	5 3/4" Deck Idler Pulley
56	1	019-0007-00	.517 Square Hole Round Washer
57	1	039-6945-98	Deck Idler Assembly (Components 33,34,35,36,37)



037-6015-50  
Spindle - Aluminum - 2012 ZT

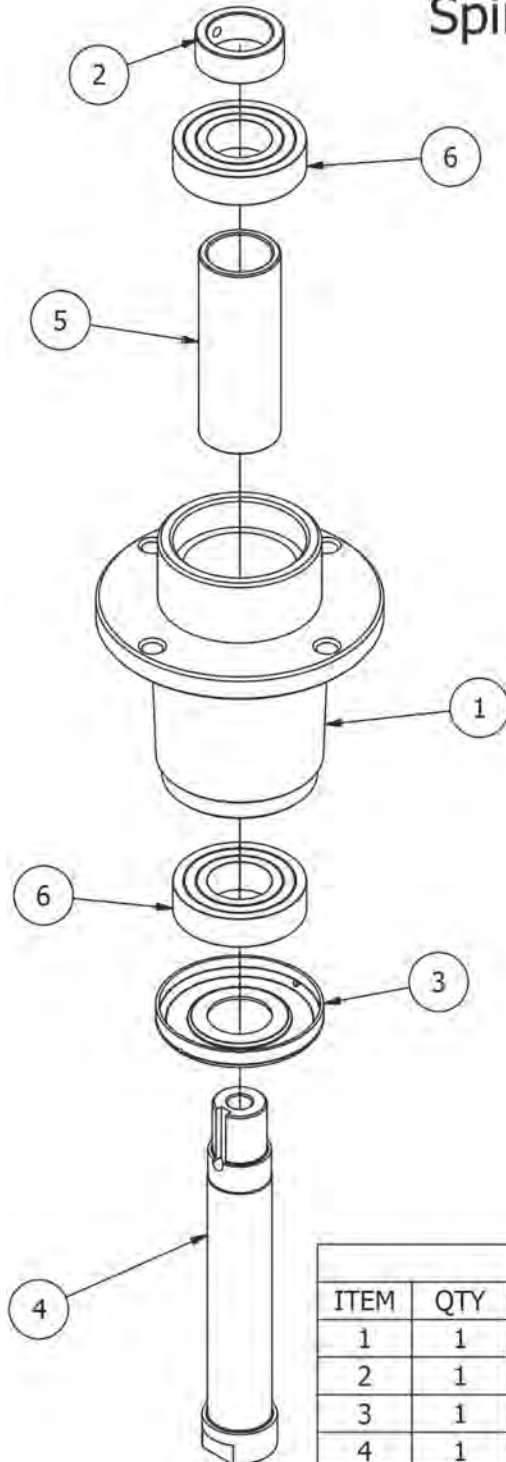

Parts List			
ITEM	QTY	PART NUMBER	DESCRIPTION
1	1	037-6017-50	ZT spindle housing
2	1	037-9050-00	Locking Collar w/ 1/4"-20 Set Screw
3	1	037-8002-00	Spindle Dust Cap
4	1	037-6026-00	ZT-AOS Spindle Shaft
5	1	037-8050-00	ZT spindle spacer
6	2	037-6023-00	Bearing - 6206





091-0902-00  
2013 CZT/ZT Logo Decal - Floorboard



091-0921-00  
ZT 725cc Decal



091-0911-00  
ZT 726cc Decal



091-0916-00  
ZT 747cc Decal



091-0903-00  
48" Deck Decal



091-0900-00  
Elite Decal - Grill



091-3309-00  
Deck Belt Route Decal



091-3017-00  
Pump Belt Route Decal



091-0904-00  
54" Deck Decal



091-0012-00  
Anti-Skid Floor Panel Decal



091-0915-00  
2014 ZT Instrument  
Panel Decal



091-3012-00  
Danger Decal - Spindle/Discharge



091-0905-00  
60" Deck Decal



091-0907-00  
CZT/ZT Brake/Steering  
Decal



091-0906-00  
CZT/ZT Steering Speed  
Decal

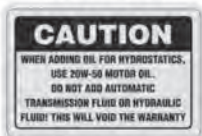

091-1020-00  
MZ Hydraulic Decal



091-3150-00  
Outlaw Warning Decal





---

# 2015 LIMITED WARRANTY FOR BAD BOY ZT MOWERS

## 1. WHAT THIS WARRANTY COVERS, AND FOR HOW LONG:

Bad Boy, Inc. will, at its option, repair or replace, without charge, any part covered by the warranty which is found to be defective in material and/or workmanship within the lesser of two (2) year\* or 200 hours after date of sale to the original retail purchaser **unless the product is used for rental, commercial, or industrial purposes in which case there is NO warranty.**

The leading edge of the deck shell will be warranted for the entire lifetime of the machine to the original purchaser against defects in materials and workmanship. Labor required to repair or replace the leading edge of the deck shell will be covered by Bad Boy, Inc for the first year and at the unit owner's expense during the balance of the lifetime of the machine.

Belts are warranted for a period of ninety (90) days against materials or workmanship defects.

Seats are warranted for a period of (6) months against material or workmanship defects.

At Bad Boy, Inc.'s request, customer will make the defective part available for inspection by Bad Boy, Inc. and/or return the defective part to Bad Boy, Inc., **transportation charges prepaid.**

## 2. WHAT THIS WARRANTY DOES NOT COVER:

A. This warranty does not cover defects caused by depreciation or damage caused by normal wear, accidents, improper maintenance, improper use or abuse of the product, alterations, or failure to follow the instruction contained in the Owner's Manual for operation and maintenance.

B. The customer shall pay any charges for making service calls and/or for transporting the mower to and from the place where the inspection and/or warranty work is performed.

**Bad Boy Inc will not be responsible for the pickup and delivery of a machine for warranty purposes.**

C. Engines are warranted separately by their respective manufacturer. The available warranties covering this item are furnished with each mower. Bad Boy, Inc does not assume any warranty obligation, liability or modification for this item, which is covered exclusively by the stated warranty of the respective manufacturers.

D. Tires, blades, deck anti-scalping wheels are considered to be consumable wear items and are therefore not warranted.

E. Batteries are warranted for six months (free replacement) from the retail purchase date against materials or workmanship defects. The battery warranty must be obtained through the battery manufacturer.

## 3. HOW TO OBTAIN SERVICE UNDER THIS WARRANTY:

A. Warranty service can be arranged by contacting the dealer where you purchased the mower. Proof of the date of purchase may be required to verify warranty coverage.

**B. Warranty claims will not be reviewed or paid unless the warranty registration is received by Bad Boy, Inc. within 30 days of the retail purchase date.**

C. Warranty claims requiring parts returned will be settled upon return of parts to Bad Boy for inspection.

D. All warranty issues must be handled through an authorized service center or dealership.

## 4. WARRANTY LIMITATION:

A. **THERE IS NO OTHER EXPRESS WARRANTY. ANY WARRANTY THAT MAY BE IMPLIED FROM THIS PURCHASE INCLUDING MERCHANTABILITY AND FITNESS FOR A PARTICULAR PURPOSE IS HEREBY LIMITED TO THE DURATION OF THIS WARRANTY AND TO THE EXTENT PERMITTED BY LAW ANY AND ALL IMPLIED WARRANTIES ARE EXCLUDED.** Some states do not allow limitations on how long an implied warranty lasts, so the above limitations may not apply to you.

B. **BAD BOY, INC. WILL NOT BE LIABLE FOR ANY INCIDENTAL, CONSEQUENTIAL, OR SPECIAL DAMAGES AND/OR EXPENSES IN CONNECTION WITH THE PURCHASE OR USE OF THE MOWER.** Some states do not allow the exclusion or limitation of incidental or consequential damages, so the above limitation(s) or exclusion(s) may not apply to you.

C. Only the warranty expressed in this limited warranty shall apply and no dealer, distributor, or individual is authorized to amend, modify, or extend this warranty in any way. Accordingly, additional statements such as dealer advertising or presentations, whether oral or written, do not constitute warranties by Bad boy, Inc., and should not be relied on.

D. This warranty extends only to turf equipment operated under normal conditions and properly serviced and maintained. The warranty expressly does not cover (i) any defects, damage or deterioration due to normal use, wear and tear, or exposure; (ii) normal maintenance services such as oil change, cleaning, lubrication, adjustment; (iii) replacement of services, items, such as oil, lubricants, spark plugs, belts, rubber hoses or other items subject to normal service replacement; (iv) damage or defects arising out of or relating to misuse, neglect, alteration, negligence or accident; (v) repair or replacement arising from operation of or use of the turf equipment which is not in accordance with operating instructions as specified in the operator's manual or other operational instructions provided by Bad Boy Inc.; (vi) repair or replacement arising as a result of any operation from turf equipment that has been altered or modified so as to, indetermination of Bad Boy, Inc., adversely affect the operation, performance or durability of the equipment or that has altered, modified or affected the turf equipment so as to change the intended use of the product; (vii) repair or replacement necessitated by use of parts, accessories or supplies, including gasoline, oil or lubricants, incompatible with the turf equipment or other than as recommended in the operator's manual or other operational instructions provided by Bad Boy, Inc.; (viii) repairs or replacements resulting from parts or accessories which have adversely affected the operation, performance or durability of the turf equipment; or (ix) damage or defects due to or arising out of repair of turf equipment by person or persons other than an authorized Bad Boy, Inc., service dealer or the installation of parts other than genuine Bad Boy, Inc., recommended parts.

**As a condition to this warranty, customer shall have read the operator's manual and ensured the mower has been registered within 30 days of purchase.**

E. This warranty gives you specific legal rights, and you may also have other rights, which vary from state to state.



---

**Bad Boy, Inc.**  
**102 Industrial Drive**  
**Batesville, AR 72501**  
**www.badboymowers.com**

**Technical Support:** .....techsupport@badboymowers.com

**Warranty:** .....warranty@badboymowers.com

**Parts:** .....partsdept@badboymowers.com

## **WARRANTY REGISTRATION**

**Ensure selling dealership has registered mower within  
30 days of purchase to validate warranty.**

Please record your serial number, date of purchase and dealership information for your records.

Serial # \_\_\_\_\_

Date of Purchase \_\_\_\_\_

Dealer Information \_\_\_\_\_

# ZT ELITE MODEL



For additional information, please see us at  
[www.badboymowers.com](http://www.badboymowers.com)

Bad Boy, Inc.  
102 Industrial Drive  
Batesville, Arkansas 72501